

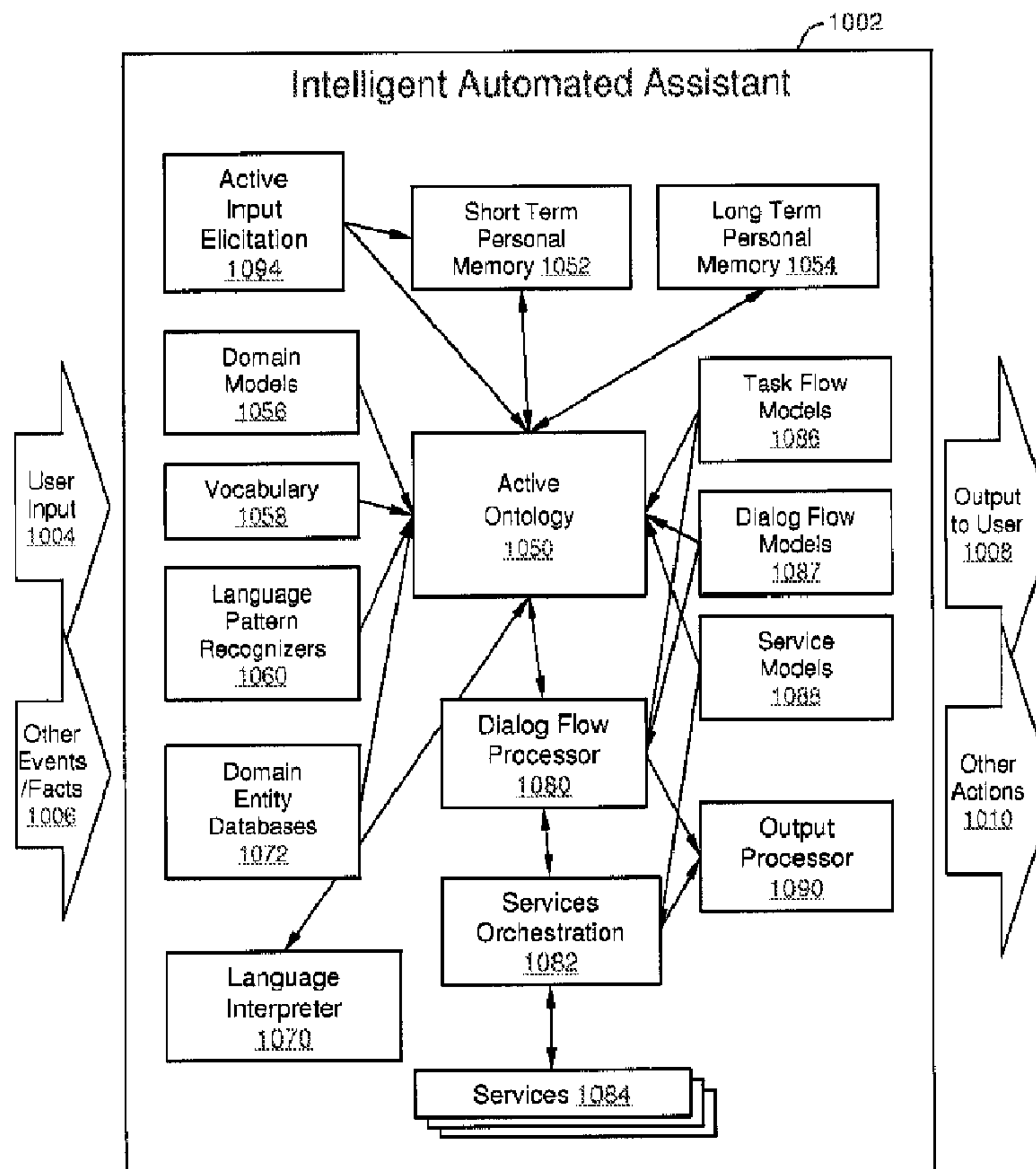

(22) **Date de dépôt/Filing Date:** 2011/01/11  
 (41) **Mise à la disp. pub./Open to Public Insp.:** 2011/07/21  
 (45) **Date de délivrance/Issue Date:** 2018/12/04  
 (62) **Demande originale/Original Application:** 2 793 118  
 (30) **Priorités/Priorities:** 2010/01/18 (US61/295,774);  
 2011/01/10 (US12/987,982)

(51) **Cl.Int./Int.Cl. G06F 17/00** (2006.01),  
**G06F 17/20** (2006.01), **G10L 15/26** (2006.01),  
**H04M 3/42** (2006.01), **G06Q 10/10** (2012.01),  
**G06F 17/30** (2006.01)  
 (72) **Inventeurs/Inventors:**  
 CHEYER, ADAM JOHN, US;  
 GUZZONI, DIDIER RENE, CH;  
 GRUBER, THOMAS ROBERT, US;  
 BRIGHAM, CHRISTOPHER DEAN, US;  
 KITTLAUS, DAG, US  
 (73) **Propriétaire/Owner:**  
 APPLE INC., US  
 (74) **Agent:** RICHES, MCKENZIE & HERBERT LLP

(54) **Titre : MAINTIEN DE L'INFORMATION DE CONTEXTE ENTRE DES INTERACTIONS UTILISATEURS AVEC UN ASSISTANT VOCAL**  
 (54) **Title: MAINTAINING CONTEXT INFORMATION BETWEEN USER INTERACTIONS WITH A VOICE ASSISTANT**



(57) **Abrégé/Abstract:**

An intelligent automated assistant system engages with the user in an integrated, conversational manner using natural language dialog, and invokes external services when appropriate to obtain information or perform various actions. The system can be

**(57) Abrégé(suite)/Abstract(continued):**

implemented using any of a number of different platforms, such as the web, email, smartphone, and the like, or any combination thereof. In one embodiment, the system is based on sets of interrelated domains and tasks, and employs additional functionality powered by external services with which the system can interact.

### Abstract

An intelligent automated assistant system engages with the user in an integrated, conversational manner using natural language dialog, and invokes external services when appropriate to obtain information or perform various actions.

- 5 The system can be implemented using any of a number of different platforms, such as the web, email, smartphone, and the like, or any combination thereof. In one embodiment, the system is based on sets of interrelated domains and tasks, and employs additional functionally powered by external services with which the system can interact.

**MAINTAINING CONTEXT INFORMATION BETWEEN  
USER INTERACTIONS WITH A VOICE ASSISTANT**

[0001] This is a divisional of Canadian Application Serial No. 2,793,118 which is a  
5 divisional of Canadian Application Serial No. 2,787,351 which in turn is the Canadian  
national phase of International Application No. PCT/US2011/020861 filed 11 January  
2011 and published 21 July 2011 under Publication No. WO 2011/088053.

**FIELD OF THE INVENTION**

[0002] The present invention relates to intelligent systems, and more specifically  
10 for classes of applications for intelligent automated assistants.

**BACKGROUND OF THE INVENTION**

[0003] Today's electronic devices are able to access a large, growing, and diverse  
quantity of functions, services, and information, both via the Internet and from other  
sources. Functionality for such devices is increasing rapidly, as many consumer devices,  
15 smartphones, tablet computers, and the like, are able to run software applications to  
perform various tasks and provide different types of information. Often, each  
application, function, website, or feature has its own user interface and its own  
operational paradigms, many of which can be burdensome to learn or overwhelming  
for users. In addition, many users may have difficulty even discovering what  
20 functionality and/or information is available on their electronic devices or on various  
websites; thus, such users may become frustrated or overwhelmed, or may simply be  
unable to use the resources available to them in an effective manner.

[0004] In particular, novice users, or individuals who are impaired or disabled in  
some manner, and/or are elderly, busy, distracted, and/or operating a vehicle may have  
25 difficulty interfacing with their electronic devices effectively, and/or engaging online  
services effectively. Such users are particularly likely to have difficulty with the large  
number of diverse and inconsistent functions, applications, and websites that may be  
available for their use.

[0005] Accordingly, existing systems are often difficult to use and to navigate, and  
30 often present users with inconsistent and overwhelming interfaces that often prevent  
the users from making effective use of the technology.

## SUMMARY

[0006] According to various embodiments of the present invention, an intelligent automated assistant is implemented on an electronic device, to facilitate user interaction with a device, and to help the user more effectively engage with local and/or remote services. In various embodiments, the intelligent automated assistant engages with the user in an integrated, conversational manner using natural language dialog, and invokes external services when appropriate to obtain information or perform various actions.

[0007] According to various embodiments, a method for operating an automated assistant, comprising: at an electronic device comprising a processor and memory storing instructions for execution by the processor: performing a first task using a first parameter; obtaining a text string from a speech input received from a user; identifying, based at least partially on the text string, a second task different from the first task or a second parameter different from the first parameter; and performing the first task using the second parameter or performing the second task using the first parameter.

[0007a] According to various embodiments, a method for operating an automated assistant, comprising: at an electronic device comprising a processor and memory storing instructions for execution by the processor: performing a first task using a first parameter; obtaining a text string from a speech input received from a user; determining whether the text string: includes a second task different from the first task and does not include a recitation of the first parameter; or includes a second parameter different from the first parameter and does not include a recitation of the first task; in accordance with a determination that the text string includes the second parameter different from the first parameter and does not include a recitation of the first parameter, performing the first task using the second parameter; and in accordance with a determination that the text string includes the second task different from the first task and does not include a recitation of the first parameter, performing the second task using the first parameter.

[0007b] According to various embodiments, a method for operating an automated assistant, comprising: at an electronic device comprising a processor and memory storing instructions for execution by the processor: performing a first task using a first parameter; providing a first response to a user based on a result of performing the first task using the first parameter; in a first operation: obtaining a first text string from a first speech input received from the user; determining whether the first text string includes a second task different from the first task, where the first text string does not include a recitation of the first parameter; and in accordance with a determination that the first text string includes the second task different from the first task and does not include a recitation of the first parameter: performing the second task using the first parameter; and providing a second response to the user based on a result of performing the second task using the first parameter; and in a second operation: obtaining a second text string from a second speech input received from the user; determining whether the second text string includes a second parameter different from the first parameter, where the second text string does not include a recitation of the first task; in accordance with a determination that the second text string includes the second parameter different from the first parameter and does not include a recitation of the first task: performing the first task using the second parameter; and providing a third response to the user based on a result of performing the first task using the second parameter.

[0008] According to various embodiments, a system for operating an intelligent automated assistant, comprising: one or more processors; and memory storing instructions that, when executed by the one or more processors, cause the processors to perform operations comprising: performing a first task using a first parameter; obtaining a text string from a speech input received from a user; identifying, based at least partially on the text string, a second task different from the first task or a second parameter different from the first parameter; and performing the first task using the second parameter or performing the second task using the first parameter.

[0008a] According to various embodiments, a system for operating an intelligent automated assistant, comprising: one or more processors; and memory storing

instructions that, when executed by the one or more processors, cause the processors to perform operations comprising: performing a first task using a first parameter; obtaining a text string from a speech input received from a user; determining whether the text string: includes a second task different from the first task and does not  
5 include a recitation of the first parameter; or includes a second parameter different from the first parameter and does not include a recitation of the first task; in accordance with a determination that the text string includes the second parameter different from the first parameter and does not include a recitation of the first parameter performing the first task using the second parameter; and in accordance  
10 with a determination that the text string includes the second task different from the first task and does not include a recitation of the first parameter, performing the second task using the first parameter.

**[0008b]** According to various embodiments, a system for operating an intelligent automated assistant, comprising: one or more processors; and memory storing  
15 instructions that, when executed by the one or more processors, cause the processors to perform operations comprising: performing a first task using a first parameter; providing a first response to a user based on a result of performing the first task using the first parameter; in a first operation: obtaining a first text string from a first speech input received from the user; determining whether the first text string includes a  
20 second task different from the first task, where the first text string does not include a recitation of the first parameter; and in accordance with a determination that the first text string includes the second task different from the first task and does not include a recitation of the first parameter: performing the second task using the first parameter; and providing a second response to the user based on a result of performing the  
25 second task using the first parameter; and in a second operation: obtaining a second text string from a second speech input received from the user; determining whether the second text string includes a second parameter different from the first parameter, where the second text string does not include a recitation of the first task; in accordance with a determination that the second text string includes the second  
30 parameter different from the first parameter and does not include a recitation of the

first task: performing the first task using the second parameter; and providing a third response to the user based on a result of performing the first task using the second parameter.

[0009] According to various embodiments, a computer readable storage medium  
5 storing instructions that, when executed by an electronic device with one or more processors, cause the processors to perform operations comprising: performing a first task using a first parameter; obtaining a text string from a speech input received from a user; identifying, based at least partially on the text string, a second task different from the first task or a second parameter different from the first parameter; and  
10 performing the first task using the second parameter or performing the second task using the first parameter.

[0009a] According to various embodiments, a computer readable storage medium storing instructions that, when executed by an electronic device with one or more processors, cause the processors to perform operations comprising: performing  
15 a first task using a first parameter; obtaining a text string from a speech input received from a user; determining whether the text string: includes a second task different from the first task and does not include a recitation of the first parameter; or includes a second parameter different from the first parameter and does not include a recitation of the first task; in accordance with a determination that the text string  
20 includes the second parameter different from the first parameter and does not include a recitation of the first parameter, performing the first task using the second parameter; and in accordance with a determination that the text string includes the second task different from the first task and does not include a recitation of the first parameter, performing the second task using the first parameter.

[0009b] According to various embodiments, a non-transitory computer readable storage medium storing instructions that, when executed by an electronic device with one or more processors, cause the processors to perform operations comprising:  
performing a first task using a first parameter; providing a first response to a user based on a result of performing the first task using the first parameter; in a first  
30 operation: obtaining a first text string from a first speech input received from the user;



determining whether the first text string includes a second task different from the first task, where the first text string does not include a recitation of the first parameter; and in accordance with a determination that the first text string includes the second task different from the first task and does not include a recitation of the first parameter:  
5 performing the second task using the first parameter; and providing a second response to the user based on a result of performing the second task using the first parameter; and in a second operation: obtaining a second text string from a second speech input received from the user; determining whether the second text string includes a second parameter different from the first parameter, where the second text  
10 string does not include a recitation of the first task; in accordance with a determination that the second text string includes the second parameter different from the first parameter and does not include a recitation of the first task: performing the first task using the second parameter; and providing a third response to the user based on a result of performing the first task using the second parameter.

15 [0009c] According to various embodiments, a method for launching an application on a user device using a digital assistant, comprising: at an electronic device comprising a processor and memory storing instructions for execution by the processor: providing, at the user device, a graphical user interface including an at least partially speech-based conversational interface for interacting with a user, the  
20 graphical user interface displaying at least a portion of a conversational interaction between the user and the user device; obtaining context information associated with an interaction between the user and the user device; receiving a speech input from the user through the conversational interface; processing the speech input to determine a user intent associated with the speech input; and upon determination that the user  
25 intent associated with the speech input is for invoking a software application installed on the user device: invoking the software application on the user device external to the graphical user interface including the conversational interface; and providing a response based on the user intent and the context information.

[0009d] According to various embodiments, a system, comprising: one or more  
30 processors; memory storing instructions, the instructions configured to be executed

by the one or more processors and cause the one or more processors to perform operations comprising: at a user device comprising a processor and memory storing instructions for execution by the processor: providing, at a user device, a graphical user interface including an at least partially speech-based conversational interface for  
5 interacting with a user, the graphical user interface displaying at least a portion of a conversational interaction between the user and the user device; obtaining context information associated with an interaction between the user and the user device; receiving a speech input from the user through the conversational interface; processing the speech input to determine a user intent associated with the speech  
10 input; and upon determination that the user intent associated with the speech input is for invoking a software application installed on the user device: invoking the software application on the user device external to the graphical user interface including the conversational interface; and providing a response based on the user intent and the context information.

15 **[0009e]** According to various embodiments, a non-transitory computer readable storage medium storing one or more programs, the one or more programs comprising instructions, which when executed by a user device, cause the device to: provide, at the user device, a graphical user interface including an at least partially speech-based conversational interface for interacting with a user, the graphical user interface  
20 displaying at least a portion of a conversational interaction between the user and the user device, the graphical user interface displaying at least a portion of a conversational interaction between the user and the user device; obtain context information associated with an interaction between the user and the user device; receive a speech input from the user through the conversational interface; process the  
25 speech input to determine a user intent associated with the speech input; and upon determination that the user intent associated with the speech input is for invoking a software application installed on the user device: invoke the software application on the user device external to the graphical user interface including the conversational interface; and provide a response based on the user intent and the context  
30 information.

[0010] According to various embodiments of the present invention, the intelligent automated assistant integrates a variety of capabilities provided by different software components (e.g., for supporting natural language recogni-

tion and dialog, multimodal input, personal information management, task flow management, orchestrating distributed services, and the like). Furthermore, to offer intelligent interfaces and useful functionality to users, the intelligent automated assistant of the present invention may, in at least some embodiments, coordinate these components and services. The conversation interface, and the ability to obtain information and perform follow-on task, are implemented, in at least some embodiments, by coordinating various components such as language components, dialog components, task management components, information management components and/or a plurality of external services.

**[0011]** According to various embodiments of the present invention, intelligent automated assistant systems may be configured, designed, and/or operable to provide various different types of operations, functionalities, and/or features, and/or to combine a plurality of features, operations, and applications of an electronic device on which it is installed. In some embodiments, the intelligent automated assistant systems of the present invention can perform any or all of: actively eliciting input from a user, interpreting user intent, disambiguating among competing interpretations, requesting and receiving clarifying information as needed, and performing (or initiating) actions based on the discerned intent. Actions can be performed, for example, by activating and/or interfacing with any applications or services that may be available on an electronic device, as well as services that are available over an electronic network such as the Internet. In various embodiments, such activation of external services can be performed via APIs or by any other suitable mechanism. In this manner, the intelligent automated assistant systems of various embodiments of the present invention can unify, simplify, and improve the user's experience with respect to many different applications and functions of an electronic device, and with respect to services that may be available over the Internet. The user can thereby be relieved of the burden of learning what functionality may be available on the device and on web-connected services,

how to interface with such services to get what he or she wants, and how to interpret the output received from such services; rather, the assistant of the present invention can act as a go-between between the user and such diverse services.

**[0012]** In addition, in various embodiments, the assistant of the present invention provides a conversational interface that the user may find more intuitive and less burdensome than conventional graphical user interfaces. The user can engage in a form of conversational dialog with the assistant using any of a number of available input and output mechanisms, such as for example speech, graphical user interfaces (buttons and links), text entry, and the like. The system can be implemented using any of a number of different platforms, such as device APIs, the web, email, and the like, or any combination thereof. Requests for additional input can be presented to the user in the context of such a conversation. Short and long term memory can be engaged so that user input can be interpreted in proper context given previous events and communications within a given session, as well as historical and profile information about the user.

**[0013]** In addition, in various embodiments, context information derived from user interaction with a feature, operation, or application on a device can be used to streamline the operation of other features, operations, or applications on the device or on other devices. For example, the intelligent automated assistant can use the context of a phone call (such as the person called) to streamline the initiation of a text message (for example to determine that the text message should be sent to the same person, without the user having to explicitly specify the recipient of the text message). The intelligent automated assistant of the present invention can thereby interpret instructions such as "send him a text message", wherein the "him" is interpreted according to context information derived from a current phone call, and/or from any feature, operation, or application on the device. In various embodiments, the intelligent automated assistant takes into account various types of avail-

able context data to determine which address book contact to use, which contact data to use, which telephone number to use for the contact, and the like, so that the user need not re-specify such information manually.

**[0014]** In various embodiments, the assistant can also take into account external events and respond accordingly, for example, to initiate action, initiate communication with the user, provide alerts, and/or modify previously initiated action in view of the external events. If input is required from the user, a conversational interface can again be used.

**[0015]** In one embodiment, the system is based on sets of interrelated domains and tasks, and employs additional functionally powered by external services with which the system can interact. In various embodiments, these external services include web-enabled services, as well as functionality related to the hardware device itself. For example, in an embodiment where the intelligent automated assistant is implemented on a smartphone, personal digital assistant, tablet computer, or other device, the assistant can control many operations and functions of the device, such as to dial a telephone number, send a text message, set reminders, add events to a calendar, and the like.

**[0016]** In various embodiments, the system of the present invention can be implemented to provide assistance in any of a number of different domains. Examples include:

- Local Services (including location- and time-specific services such as restaurants, movies, automated teller machines (ATMs), events, and places to meet);
- Personal and Social Memory Services (including action items, notes, calendar events, shared links, and the like);
- E-commerce (including online purchases of items such as books, DVDs, music, and the like);
- Travel Services (including flights, hotels, attractions, and the like).

**[0017]** One skilled in the art will recognize that the above list of domains is merely exemplary. In addition, the system of the present invention can be implemented in any combination of domains.

**[0018]** In various embodiments, the intelligent automated assistant systems disclosed herein may be configured or designed to include functionality for automating the application of data and services available over the Internet to discover, find, choose among, purchase, reserve, or order products and services. In addition to automating the process of using these data and services, at least one intelligent automated assistant system embodiment disclosed herein may also enable the combined use of several sources of data and services at once. For example, it may combine information about products from several review sites, check prices and availability from multiple distributors, and check their locations and time constraints, and help a user find a personalized solution to their problem. Additionally, at least one intelligent automated assistant system embodiment disclosed herein may be configured or designed to include functionality for automating the use of data and services available over the Internet to discover, investigate, select among, reserve, and otherwise learn about things to do (including but not limited to movies, events, performances, exhibits, shows and attractions); places to go (including but not limited to travel destinations, hotels and other places to stay, landmarks and other sites of interest, etc.); places to eat or drink (such as restaurants and bars), times and places to meet others, and any other source of entertainment or social interaction which may be found on the Internet. Additionally, at least one intelligent automated assistant system embodiment disclosed herein may be configured or designed to include functionality for enabling the operation of applications and services via natural language dialog that may be otherwise provided by dedicated applications with graphical user interfaces including search (including location-based search); navigation (maps and directions); database lookup (such as finding businesses or people by name or other properties); getting weather conditions and forecasts, check-

ing the price of market items or status of financial transactions; monitoring traffic or the status of flights; accessing and updating calendars and schedules; managing reminders, alerts, tasks and projects; communicating over email or other messaging platforms; and operating devices locally or remotely (e.g., dialing telephones, controlling light and temperature, controlling home security devices, playing music or video, etc.). Further, at least one intelligent automated assistant system embodiment disclosed herein may be configured or designed to include functionality for identifying, generating, and/or providing personalized recommendations for activities, products, services, source of entertainment, time management, or any other kind of recommendation service that benefits from an interactive dialog in natural language and automated access to data and services.

**[0019]** In various embodiments, the intelligent automated assistant of the present invention can control many features and operations of an electronic device. For example, the intelligent automated assistant can call services that interface with functionality and applications on a device via APIs or by other means, to perform functions and operations that might otherwise be initiated using a conventional user interface on the device. Such functions and operations may include, for example, setting an alarm, making a telephone call, sending a text message or email message, adding a calendar event, and the like. Such functions and operations may be performed as add-on functions in the context of a conversational dialog between a user and the assistant. Such functions and operations can be specified by the user in the context of such a dialog, or they may be automatically performed based on the context of the dialog. One skilled in the art will recognize that the assistant can thereby be used as a control mechanism for initiating and controlling various operations on the electronic device, which may be used as an alternative to conventional mechanisms such as buttons or graphical user interfaces.



**BRIEF DESCRIPTION OF THE DRAWINGS**

**[0020]** The accompanying drawings illustrate several embodiments of the invention and, together with the description, serve to explain the principles of the invention according to the embodiments. One skilled in the art will recognize that the particular embodiments illustrated in the drawings are merely exemplary, and are not intended to limit the scope of the present invention.

**[0021]** Fig. 1 is a block diagram depicting an example of one embodiment of an intelligent automated assistant system.

**[0022]** Fig. 2 illustrates an example of an interaction between a user and an intelligent automated assistant according to at least one embodiment.

**[0023]** Fig. 3 is a block diagram depicting a computing device suitable for implementing at least a portion of an intelligent automated assistant according to at least one embodiment.

**[0024]** Fig. 4 is a block diagram depicting an architecture for implementing at least a portion of an intelligent automated assistant on a standalone computing system, according to at least one embodiment.

**[0025]** Fig. 5 is a block diagram depicting an architecture for implementing at least a portion of an intelligent automated assistant on a distributed computing network, according to at least one embodiment.

**[0026]** Fig. 6 is a block diagram depicting a system architecture illustrating several different types of clients and modes of operation.

**[0027]** Fig. 7 is a block diagram depicting a client and a server, which communicate with each other to implement the present invention according to one embodiment.

**[0028]** Fig. 8 is a block diagram depicting a fragment of an active ontology according to one embodiment.

**[0029]** Fig. 9 is a block diagram depicting an example of an alternative embodiment of an intelligent automated assistant system.

**[0030]** Fig. 10 is a flow diagram depicting a method of operation for active input elicitation component(s) according to one embodiment.

**[0031]** Fig. 11 is a flow diagram depicting a method for active typed-input elicitation according to one embodiment.

**[0032]** Figs. 12 to 21 are screen shots illustrating some portions of some of the procedures for active typed-input elicitation according to one embodiment.

**[0033]** Fig. 22 is a flow diagram depicting a method for active input elicitation for voice or speech input according to one embodiment.

**[0034]** Fig. 23 is a flow diagram depicting a method for active input elicitation for GUI-based input according to one embodiment.

**[0035]** Fig. 24 is a flow diagram depicting a method for active input elicitation at the level of a dialog flow according to one embodiment.

**[0036]** Fig. 25 is a flow diagram depicting a method for active monitoring for relevant events according to one embodiment.

**[0037]** Fig. 26 is a flow diagram depicting a method for multimodal active input elicitation according to one embodiment.

**[0038]** Fig. 27 is a set of screen shots illustrating an example of various types of functions, operations, actions, and/or other features which may be provided by domain models component(s) and services orchestration according to one embodiment.

**[0039]** Fig. 28 is a flow diagram depicting an example of a method for natural language processing according to one embodiment.

**[0040]** Fig. 29 is a screen shot illustrating natural language processing according to one embodiment.

**[0041]** Figs. 30 and 31 are screen shots illustrating an example of various types of functions, operations, actions, and/or other features which may be provided by dialog flow processor component(s) according to one embodiment.

**[0042]** Fig. 32 is a flow diagram depicting a method of operation for dialog flow processor component(s) according to one embodiment.

- [0043]** Fig. 33 is a flow diagram depicting an automatic call and response procedure, according to one embodiment.
- [0044]** Fig. 34 is a flow diagram depicting an example of task flow for a constrained selection task according to one embodiment.
- [0045]** Figs. 35 and 36 are screen shots illustrating an example of the operation of constrained selection task according to one embodiment.
- [0046]** Fig. 37 is a flow diagram depicting an example of a procedure for executing a service orchestration procedure according to one embodiment.
- [0047]** Fig. 38 is a flow diagram depicting an example of a service invocation procedure according to one embodiment.
- [0048]** Fig. 39 is a flow diagram depicting an example of a multiphase output procedure according to one embodiment.
- [0049]** Figs. 40 and 41 are screen shots depicting examples of output processing according to one embodiment.
- [0050]** Fig. 42 is a flow diagram depicting an example of multimodal output processing according to one embodiment.
- [0051]** Figs. 43A and 43B are screen shots depicting an example of the use of short term personal memory component(s) to maintain dialog context while changing location, according to one embodiment.
- [0052]** Figs. 44A through 44C are screen shots depicting an example of the use of long term personal memory component(s), according to one embodiment.
- [0053]** Fig. 45 depicts an example of an abstract model for a constrained selection task.
- [0054]** Fig. 46 depicts an example of a dialog flow model to help guide the user through a search process.
- [0055]** Fig. 47 is a flow diagram depicting a method of constrained selection according to one embodiment.

## DETAILED DESCRIPTION OF THE EMBODIMENTS

**[0056]** Various techniques will now be described in detail with reference to a few example embodiments thereof as illustrated in the accompanying drawings. In the following description, numerous specific details are set forth in order to provide a thorough understanding of one or more aspects and/or features described or reference herein. It will be apparent, however, to one skilled in the art, that one or more aspects and/or features described or reference herein may be practiced without some or all of these specific details. In other instances, well known process steps and/or structures have not been described in detail in order to not obscure some of the aspects and/or features described or reference herein.

**[0057]** One or more different inventions may be described in the present application. Further, for one or more of the invention(s) described herein, numerous embodiments may be described in this patent application, and are presented for illustrative purposes only. The described embodiments are not intended to be limiting in any sense. One or more of the invention(s) may be widely applicable to numerous embodiments, as is readily apparent from the disclosure. These embodiments are described in sufficient detail to enable those skilled in the art to practice one or more of the invention(s), and it is to be understood that other embodiments may be utilized and that structural, logical, software, electrical and other changes may be made without departing from the scope of the one or more of the invention(s). Accordingly, those skilled in the art will recognize that the one or more of the invention(s) may be practiced with various modifications and alterations. Particular features of one or more of the invention(s) may be described with reference to one or more particular embodiments or figures that form a part of the present disclosure, and in which are shown, by way of illustration, specific embodiments of one or more of the invention(s). It should be understood, however, that such features are not limited to usage in the one or more particular embodiments or figures with reference to which they are described. The present disclosure

is neither a literal description of all embodiments of one or more of the invention(s) nor a listing of features of one or more of the invention(s) that must be present in all embodiments.

**[0058]** Headings of sections provided in this patent application and the title of this patent application are for convenience only, and are not to be taken as limiting the disclosure in any way.

**[0059]** Devices that are in communication with each other need not be in continuous communication with each other, unless expressly specified otherwise. In addition, devices that are in communication with each other may communicate directly or indirectly through one or more intermediaries.

**[0060]** A description of an embodiment with several components in communication with each other does not imply that all such components are required. To the contrary, a variety of optional components are described to illustrate the wide variety of possible embodiments of one or more of the invention(s).

**[0061]** Further, although process steps, method steps, algorithms or the like may be described in a sequential order, such processes, methods and algorithms may be configured to work in alternate orders. In other words, any sequence or order of steps that may be described in this patent application does not, in and of itself, indicate a requirement that the steps be performed in that order. The steps of described processes may be performed in any order practical. Further, some steps may be performed simultaneously despite being described or implied as occurring non-simultaneously (e.g., because one step is described after the other step). Moreover, the illustration of a process by its depiction in a drawing does not imply that the illustrated process is exclusive of other variations and modifications thereto, does not imply that the illustrated process or any of its steps are necessary to one or more of the invention(s), and does not imply that the illustrated process is preferred.

**[0062]** When a single device or article is described, it will be readily apparent that more than one device/article (whether or not they cooperate) may be

used in place of a single device/article. Similarly, where more than one device or article is described (whether or not they cooperate), it will be readily apparent that a single device/article may be used in place of the more than one device or article.

**[0063]** The functionality and/or the features of a device may be alternatively embodied by one or more other devices that are not explicitly described as having such functionality/features. Thus, other embodiments of one or more of the invention(s) need not include the device itself.

**[0064]** Techniques and mechanisms described or reference herein will sometimes be described in singular form for clarity. However, it should be noted that particular embodiments include multiple iterations of a technique or multiple instantiations of a mechanism unless noted otherwise.

**[0065]** Although described within the context of intelligent automated assistant technology, it may be understood that the various aspects and techniques described herein (such as those associated with active ontologies, for example) may also be deployed and/or applied in other fields of technology involving human and/or computerized interaction with software.

**[0066]** Other aspects relating to intelligent automated assistant technology (e.g., which may be utilized by, provided by, and/or implemented at one or more intelligent automated assistant system embodiments described herein) are disclosed in one or more of the following references:

- U.S. Provisional Patent Application Serial No. 61/295,774 for “Intelligent Automated Assistant”, related to U.S. Published Application No. US 2012/0016678 A1, published on January 19, 2012;
- U.S. Patent Application Serial No. 11/518,292 for “Method And Apparatus for Building an Intelligent Automated Assistant”, filed September 8, 2006, and published as US 2007/0100790 A1 on May 3, 2007.

**Hardware Architecture**

**[0067]** Generally, the intelligent automated assistant techniques disclosed herein may be implemented on hardware or a combination of software and hardware. For example, they may be implemented in an operating system kernel, in a separate user process, in a library package bound into network applications, on a specially constructed machine, or on a network interface card. In a specific embodiment, the techniques disclosed herein may be implemented in software such as an operating system or in an application running on an operating system.

**[0068]** Software/hardware hybrid implementation(s) of at least some of the intelligent automated assistant embodiment(s) disclosed herein may be implemented on a programmable machine selectively activated or reconfigured by a computer program stored in memory. Such network devices may have multiple network interfaces which may be configured or designed to utilize different types of network communication protocols. A general architecture for some of these machines may appear from the descriptions disclosed herein. According to specific embodiments, at least some of the features and/or functionalities of the various intelligent automated assistant embodiments disclosed herein may be implemented on one or more general-purpose network host machines such as an end-user computer system, computer, network server or server system, mobile computing device (e.g., personal digital assistant, mobile phone, smartphone, laptop, tablet computer, or the like), consumer electronic device, music player, or any other suitable electronic device, router, switch, or the like, or any combination thereof. In at least some embodiments, at least some of the features and/or functionalities of the various intelligent automated assistant embodiments disclosed herein may be implemented in one or more virtualized computing environments (e.g., network computing clouds, or the like).

**[0069]** Referring now to Fig. 3, there is shown a block diagram depicting a computing device 60 suitable for implementing at least a portion of the intel-

ligent automated assistant features and/or functionalities disclosed herein. Computing device 60 may be, for example, an end-user computer system, network server or server system, mobile computing device (e.g., personal digital assistant, mobile phone, smartphone, laptop, tablet computer, or the like), consumer electronic device, music player, or any other suitable electronic device, or any combination or portion thereof. Computing device 60 may be adapted to communicate with other computing devices, such as clients and/or servers, over a communications network such as the Internet, using known protocols for such communication, whether wireless or wired.

**[0070]** In one embodiment, computing device 60 includes central processing unit (CPU) 62, interfaces 68, and a bus 67 (such as a peripheral component interconnect (PCI) bus). When acting under the control of appropriate software or firmware, CPU 62 may be responsible for implementing specific functions associated with the functions of a specifically configured computing device or machine. For example, in at least one embodiment, a user's personal digital assistant (PDA) may be configured or designed to function as an intelligent automated assistant system utilizing CPU 62, memory 61, 65, and interface(s) 68. In at least one embodiment, the CPU 62 may be caused to perform one or more of the different types of intelligent automated assistant functions and/or operations under the control of software modules/components, which for example, may include an operating system and any appropriate applications software, drivers, and the like.

**[0071]** CPU 62 may include one or more processor(s) 63 such as, for example, a processor from the Motorola or Intel family of microprocessors or the MIPS family of microprocessors. In some embodiments, processor(s) 63 may include specially designed hardware (e.g., application-specific integrated circuits (ASICs), electrically erasable programmable read-only memories (EEPROMs), field-programmable gate arrays (FPGAs), and the like) for controlling the operations of computing device 60. In a specific embodiment, a memory 61 (such as non-volatile random access memory (RAM) and/or read-



only memory (ROM)) also forms part of CPU 62. However, there are many different ways in which memory may be coupled to the system. Memory block 61 may be used for a variety of purposes such as, for example, caching and/or storing data, programming instructions, and the like.

**[0072]** As used herein, the term “processor” is not limited merely to those integrated circuits referred to in the art as a processor, but broadly refers to a microcontroller, a microcomputer, a programmable logic controller, an application-specific integrated circuit, and any other programmable circuit.

**[0073]** In one embodiment, interfaces 68 are provided as interface cards (sometimes referred to as “line cards”). Generally, they control the sending and receiving of data packets over a computing network and sometimes support other peripherals used with computing device 60. Among the interfaces that may be provided are Ethernet interfaces, frame relay interfaces, cable interfaces, DSL interfaces, token ring interfaces, and the like. In addition, various types of interfaces may be provided such as, for example, universal serial bus (USB), Serial, Ethernet, Firewire, PCI, parallel, radio frequency (RF), Bluetooth™, near-field communications (e.g., using near-field magnetics), 802.11 (WiFi), frame relay, TCP/IP, ISDN, fast Ethernet interfaces, Gigabit Ethernet interfaces, asynchronous transfer mode (ATM) interfaces, high-speed serial interface (HSSI) interfaces, Point of Sale (POS) interfaces, fiber data distributed interfaces (FDDIs), and the like. Generally, such interfaces 68 may include ports appropriate for communication with the appropriate media. In some cases, they may also include an independent processor and, in some instances, volatile and/or non-volatile memory (e.g., RAM).

**[0074]** Although the system shown in Fig. 3 illustrates one specific architecture for a computing device 60 for implementing the techniques of the invention described herein, it is by no means the only device architecture on which at least a portion of the features and techniques described herein may be implemented. For example, architectures having one or any number of processors 63 can be used, and such processors 63 can be present in a single

device or distributed among any number of devices. In one embodiment, a single processor 63 handles communications as well as routing computations. In various embodiments, different types of intelligent automated assistant features and/or functionalities may be implemented in an intelligent automated assistant system which includes a client device (such as a personal digital assistant or smartphone running client software) and server system(s) (such as a server system described in more detail below).

**[0075]** Regardless of network device configuration, the system of the present invention may employ one or more memories or memory modules (such as, for example, memory block 65) configured to store data, program instructions for the general-purpose network operations and/or other information relating to the functionality of the intelligent automated assistant techniques described herein. The program instructions may control the operation of an operating system and/or one or more applications, for example. The memory or memories may also be configured to store data structures, keyword taxonomy information, advertisement information, user click and impression information, and/or other specific non-program information described herein.

**[0076]** Because such information and program instructions may be employed to implement the systems/methods described herein, at least some network device embodiments may include nontransitory machine-readable storage media, which, for example, may be configured or designed to store program instructions, state information, and the like for performing various operations described herein. Examples of such nontransitory machine-readable storage media include, but are not limited to, magnetic media such as hard disks, floppy disks, and magnetic tape; optical media such as CD-ROM disks; magneto-optical media such as floptical disks, and hardware devices that are specially configured to store and perform program instructions, such as read-only memory devices (ROM), flash memory, memristor memory, random access memory (RAM), and the like. Examples of program instructions include both machine code, such as produced by a compiler, and files

containing higher level code that may be executed by the computer using an interpreter.

**[0077]** In one embodiment, the system of the present invention is implemented on a standalone computing system. Referring now to Fig. 4, there is shown a block diagram depicting an architecture for implementing at least a portion of an intelligent automated assistant on a standalone computing system, according to at least one embodiment. Computing device 60 includes processor(s) 63 which run software for implementing intelligent automated assistant 1002. Input device 1206 can be of any type suitable for receiving user input, including for example a keyboard, touchscreen, microphone (for example, for voice input), mouse, touchpad, trackball, five-way switch, joystick, and/or any combination thereof. Output device 1207 can be a screen, speaker, printer, and/or any combination thereof. Memory 1210 can be random-access memory having a structure and architecture as are known in the art, for use by processor(s) 63 in the course of running software. Storage device 1208 can be any magnetic, optical, and/or electrical storage device for storage of data in digital form; examples include flash memory, magnetic hard drive, CD-ROM, and/or the like.

**[0078]** In another embodiment, the system of the present invention is implemented on a distributed computing network, such as one having any number of clients and/or servers. Referring now to Fig. 5, there is shown a block diagram depicting an architecture for implementing at least a portion of an intelligent automated assistant on a distributed computing network, according to at least one embodiment.

**[0079]** In the arrangement shown in Fig. 5, any number of clients 1304 are provided; each client 1304 may run software for implementing client-side portions of the present invention. In addition, any number of servers 1340 can be provided for handling requests received from clients 1304. Clients 1304 and servers 1340 can communicate with one another via electronic network 1361,

such as the Internet. Network 1361 may be implemented using any known network protocols, including for example wired and/or wireless protocols.

**[0080]** In addition, in one embodiment, servers 1340 can call external services 1360 when needed to obtain additional information or refer to store data concerning previous interactions with particular users. Communications with external services 1360 can take place, for example, via network 1361. In various embodiments, external services 1360 include web-enabled services and/or functionality related to or installed on the hardware device itself. For example, in an embodiment where assistant 1002 is implemented on a smartphone or other electronic device, assistant 1002 can obtain information stored in a calendar application (“app”), contacts, and/or other sources.

**[0081]** In various embodiments, assistant 1002 can control many features and operations of an electronic device on which it is installed. For example, assistant 1002 can call external services 1360 that interface with functionality and applications on a device via APIs or by other means, to perform functions and operations that might otherwise be initiated using a conventional user interface on the device. Such functions and operations may include, for example, setting an alarm, making a telephone call, sending a text message or email message, adding a calendar event, and the like. Such functions and operations may be performed as add-on functions in the context of a conversational dialog between a user and assistant 1002. Such functions and operations can be specified by the user in the context of such a dialog, or they may be automatically performed based on the context of the dialog. One skilled in the art will recognize that assistant 1002 can thereby be used as a control mechanism for initiating and controlling various operations on the electronic device, which may be used as an alternative to conventional mechanisms such as buttons or graphical user interfaces.

**[0082]** For example, the user may provide input to assistant 1002 such as “I need to wake tomorrow at 8am”. Once assistant 1002 has determined the user’s intent, using the techniques described herein, assistant 1002 can call ex-

ternal services 1340 to interface with an alarm clock function or application on the device. Assistant 1002 sets the alarm on behalf of the user. In this manner, the user can use assistant 1002 as a replacement for conventional mechanisms for setting the alarm or performing other functions on the device. If the user's requests are ambiguous or need further clarification, assistant 1002 can use the various techniques described herein, including active elicitation, paraphrasing, suggestions, and the like, to obtain the needed information so that the correct services 1340 are called and the intended action taken. In one embodiment, assistant 1002 may prompt the user for confirmation before calling a service 1340 to perform a function. In one embodiment, a user can selectively disable assistant's 1002 ability to call particular services 1340, or can disable all such service-calling if desired.

**[0083]** The system of the present invention can be implemented with many different types of clients 1304 and modes of operation. Referring now to Fig. 6, there is shown a block diagram depicting a system architecture illustrating several different types of clients 1304 and modes of operation. One skilled in the art will recognize that the various types of clients 1304 and modes of operation shown in Fig. 6 are merely exemplary, and that the system of the present invention can be implemented using clients 1304 and/or modes of operation other than those depicted. Additionally, the system can include any or all of such clients 1304 and/or modes of operation, alone or in any combination. Depicted examples include:

- Computer devices with input/output devices and/or sensors 1402. A client component may be deployed on any such computer device 1402. At least one embodiment may be implemented using a web browser 1304A or other software application for enabling communication with servers 1340 via network 1361. Input and output channels may of any type, including for example visual and/or auditory channels. For example, in one embodiment, the system of the invention can be implemented using voice-based communica-

tion methods, allowing for an embodiment of the assistant for the blind whose equivalent of a web browser is driven by speech and uses speech for output.

- Mobile Devices with I/O and sensors 1406, for which the client may be implemented as an application on the mobile device 1304B. This includes, but is not limited to, mobile phones, smartphones, personal digital assistants, tablet devices, networked game consoles, and the like.
- Consumer Appliances with I/O and sensors 1410, for which the client may be implemented as an embedded application on the appliance 1304C.
- Automobiles and other vehicles with dashboard interfaces and sensors 1414, for which the client may be implemented as an embedded system application 1304D. This includes, but is not limited to, car navigation systems, voice control systems, in-car entertainment systems, and the like.
- Networked computing devices such as routers 1418 or any other device that resides on or interfaces with a network, for which the client may be implemented as a device-resident application 1304E.
- Email clients 1424, for which an embodiment of the assistant is connected via an Email Modality Server 1426. Email Modality server 1426 acts as a communication bridge, for example taking input from the user as email messages sent to the assistant and sending output from the assistant to the user as replies.
- Instant messaging clients 1428, for which an embodiment of the assistant is connected via a Messaging Modality Server 1430. Messaging Modality server 1430 acts as a communication bridge, taking input from the user as messages sent to the assistant and sending output from the assistant to the user as messages in reply.

- Voice telephones 1432, for which an embodiment of the assistant is connected via a Voice over Internet Protocol (VoIP) Modality Server 1430. VoIP Modality server 1430 acts as a communication bridge, taking input from the user as voice spoken to the assistant and sending output from the assistant to the user, for example as synthesized speech, in reply.

**[0084]** For messaging platforms including but not limited to email, instant messaging, discussion forums, group chat sessions, live help or customer support sessions and the like, assistant 1002 may act as a participant in the conversations. Assistant 1002 may monitor the conversation and reply to individuals or the group using one or more the techniques and methods described herein for one-to-one interactions.

**[0085]** In various embodiments, functionality for implementing the techniques of the present invention can be distributed among any number of client and/or server components. For example, various software modules can be implemented for performing various functions in connection with the present invention, and such modules can be variously implemented to run on server and/or client components. Referring now to Fig. 7, there is shown an example of a client 1304 and a server 1340, which communicate with each other to implement the present invention according to one embodiment. Fig. 7 depicts one possible arrangement by which software modules can be distributed among client 1304 and server 1340. One skilled in the art will recognize that the depicted arrangement is merely exemplary, and that such modules can be distributed in many different ways. In addition, any number of clients 1304 and/or servers 1340 can be provided, and the modules can be distributed among these clients 1304 and/or servers 1340 in any of a number of different ways.

**[0086]** In the example of Fig. 7, input elicitation functionality and output processing functionality are distributed among client 1304 and server 1340, with client part of input elicitation 1094a and client part of output processing

1092a located at client 1304, and server part of input elicitation 1094b and server part of output processing 1092b located at server 1340. The following components are located at server 1340:

- complete vocabulary 1058b;
- complete library of language pattern recognizers 1060b;
- master version of short term personal memory 1052b;
- master version of long term personal memory 1054b.

**[0087]** In one embodiment, client 1304 maintains subsets and/or portions of these components locally, to improve responsiveness and reduce dependence on network communications. Such subsets and/or portions can be maintained and updated according to well known cache management techniques. Such subsets and/or portions include, for example:

- subset of vocabulary 1058a;
- subset of library of language pattern recognizers 1060a;
- cache of short term personal memory 1052a;
- cache of long term personal memory 1054a.

**[0088]** Additional components may be implemented as part of server 1340, including for example:

- language interpreter 1070;
- dialog flow processor 1080;
- output processor 1090;
- domain entity databases 1072;
- task flow models 1086;
- services orchestration 1082;
- service capability models 1088.

**[0089]** Each of these components will be described in more detail below. Server 1340 obtains additional information by interfacing with external services 1360 when needed.



### ***Conceptual Architecture***

**[0090]** Referring now to Fig. 1, there is shown a simplified block diagram of a specific example embodiment of an intelligent automated assistant 1002. As described in greater detail herein, different embodiments of intelligent automated assistant systems may be configured, designed, and/or operable to provide various different types of operations, functionalities, and/or features generally relating to intelligent automated assistant technology. Further, as described in greater detail herein, many of the various operations, functionalities, and/or features of the intelligent automated assistant system(s) disclosed herein may provide may enable or provide different types of advantages and/or benefits to different entities interacting with the intelligent automated assistant system(s). The embodiment shown in Fig. 1 may be implemented using any of the hardware architectures described above, or using a different type of hardware architecture.

**[0091]** For example, according to different embodiments, at least some intelligent automated assistant system(s) may be configured, designed, and/or operable to provide various different types of operations, functionalities, and/or features, such as, for example, one or more of the following (or combinations thereof):

- automate the application of data and services available over the Internet to discover, find, choose among, purchase, reserve, or order products and services. In addition to automating the process of using these data and services, intelligent automated assistant 1002 may also enable the combined use of several sources of data and services at once. For example, it may combine information about products from several review sites, check prices and availability from multiple distributors, and check their locations and time constraints, and help a user find a personalized solution to their problem.

- automate the use of data and services available over the Internet to discover, investigate, select among, reserve, and otherwise learn about things to do (including but not limited to movies, events, performances, exhibits, shows and attractions); places to go (including but not limited to travel destinations, hotels and other places to stay, landmarks and other sites of interest, and the like); places to eat or drink (such as restaurants and bars), times and places to meet others, and any other source of entertainment or social interaction which may be found on the Internet.
- enable the operation of applications and services via natural language dialog that are otherwise provided by dedicated applications with graphical user interfaces including search (including location-based search); navigation (maps and directions); database lookup (such as finding businesses or people by name or other properties); getting weather conditions and forecasts, checking the price of market items or status of financial transactions; monitoring traffic or the status of flights; accessing and updating calendars and schedules; managing reminders, alerts, tasks and projects; communicating over email or other messaging platforms; and operating devices locally or remotely (e.g., dialing telephones, controlling light and temperature, controlling home security devices, playing music or video, and the like). In one embodiment, assistant 1002 can be used to initiate, operate, and control many functions and apps available on the device.
- offer personal recommendations for activities, products, services, source of entertainment, time management, or any other kind of recommendation service that benefits from an interactive dialog in natural language and automated access to data and services.

**[0092]** According to different embodiments, at least a portion of the various types of functions, operations, actions, and/or other features provided by

intelligent automated assistant 1002 may be implemented at one or more client systems(s), at one or more server systems (s), and/or combinations thereof.

**[0093]** According to different embodiments, at least a portion of the various types of functions, operations, actions, and/or other features provided by assistant 1002 may be implemented by at least one embodiment of an automated call and response procedure, such as that illustrated and described, for example, with respect to Fig. 33.

**[0094]** Additionally, various embodiments of assistant 1002 described herein may include or provide a number of different advantages and/or benefits over currently existing intelligent automated assistant technology such as, for example, one or more of the following (or combinations thereof):

- The integration of speech-to-text and natural language understanding technology that is constrained by a set of explicit models of domains, tasks, services, and dialogs. Unlike assistant technology that attempts to implement a general-purpose artificial intelligence system, the embodiments described herein may apply the multiple sources of constraints to reduce the number of solutions to a more tractable size. This results in fewer ambiguous interpretations of language, fewer relevant domains or tasks, and fewer ways to operationalize the intent in services. The focus on specific domains, tasks, and dialogs also makes it feasible to achieve coverage over domains and tasks with human-managed vocabulary and mappings from intent to services parameters.
- The ability to solve user problems by invoking services on their behalf over the Internet, using APIs. Unlike search engines which only return links and content, some embodiments of automated assistants 1002 described herein may automate research and problem-solving activities. The ability to invoke multiple services for a given request also provides broader functionality to the user than is

achieved by visiting a single site, for instance to produce a product or service or find something to do.

- The application of personal information and personal interaction history in the interpretation and execution of user requests. Unlike conventional search engines or question answering services, the embodiments described herein use information from personal interaction history (e.g., dialog history, previous selections from results, and the like), personal physical context (e.g., user's location and time), and personal information gathered in the context of interaction (e.g., name, email addresses, physical addresses, phone numbers, account numbers, preferences, and the like). Using these sources of information enables, for example,
  - better interpretation of user input (e.g., using personal history and physical context when interpreting language);
  - more personalized results (e.g., that bias toward preferences or recent selections);
  - improved efficiency for the user (e.g., by automating steps involving the signing up to services or filling out forms).
- The use of dialog history in interpreting the natural language of user inputs. Because the embodiments may keep personal history and apply natural language understanding on user inputs, they may also use dialog context such as current location, time, domain, task step, and task parameters to interpret the new inputs. Conventional search engines and command processors interpret at least one query independent of a dialog history. The ability to use dialog history may make a more natural interaction possible, one which resembles normal human conversation.
- Active input elicitation, in which assistant 1002 actively guides and constrains the input from the user, based on the same models and information used to interpret their input. For example, assistant

1002 may apply dialog models to suggest next steps in a dialog with the user in which they are refining a request; offer completions to partially typed input based on domain and context specific possibilities; or use semantic interpretation to select from among ambiguous interpretations of speech as text or text as intent.

- The explicit modeling and dynamic management of services, with dynamic and robust services orchestration. The architecture of embodiments described enables assistant 1002 to interface with many external services, dynamically determine which services may provide information for a specific user request, map parameters of the user request to different service APIs, call multiple services at once, integrate results from multiple services, fail over gracefully on failed services, and/or efficiently maintain the implementation of services as their APIs and capabilities evolve.
- The use of active ontologies as a method and apparatus for building assistants 1002, which simplifies the software engineering and data maintenance of automated assistant systems. Active ontologies are an integration of data modeling and execution environments for assistants. They provide a framework to tie together the various sources of models and data (domain concepts, task flows, vocabulary, language pattern recognizers, dialog context, user personal information, and mappings from domain and task requests to external services. Active ontologies and the other architectural innovations described herein make it practical to build deep functionality within domains, unifying multiple sources of information and services, and to do this across a set of domains.

**[0095]** In at least one embodiment, intelligent automated assistant 1002 may be operable to utilize and/or generate various different types of data and/or other types of information when performing specific tasks and/or operations. This may include, for example, input data/information and/or out-

put data/information. For example, in at least one embodiment, intelligent automated assistant 1002 may be operable to access, process, and/or otherwise utilize information from one or more different types of sources, such as, for example, one or more local and/or remote memories, devices and/or systems. Additionally, in at least one embodiment, intelligent automated assistant 1002 may be operable to generate one or more different types of output data/information, which, for example, may be stored in memory of one or more local and/or remote devices and/or systems.

**[0096]** Examples of different types of input data/information which may be accessed and/or utilized by intelligent automated assistant 1002 may include, but are not limited to, one or more of the following (or combinations thereof):

- Voice input: from mobile devices such as mobile telephones and tablets, computers with microphones, Bluetooth headsets, automobile voice control systems, over the telephone system, recordings on answering services, audio voicemail on integrated messaging services, consumer applications with voice input such as clock radios, telephone station, home entertainment control systems, and game consoles.
- Text input from keyboards on computers or mobile devices, keypads on remote controls or other consumer electronics devices, email messages sent to the assistant, instant messages or similar short messages sent to the assistant, text received from players in multiuser game environments, and text streamed in message feeds.
- Location information coming from sensors or location-based systems. Examples include Global Positioning System (GPS) and Assisted GPS (A-GPS) on mobile phones. In one embodiment, location information is combined with explicit user input. In one embodiment, the system of the present invention is able to detect when a user is at home, based on known address information and current

location determination. In this manner, certain inferences may be made about the type of information the user might be interested in when at home as opposed to outside the home, as well as the type of services and actions that should be invoked on behalf of the user depending on whether or not he or she is at home.

- Time information from clocks on client devices. This may include, for example, time from telephones or other client devices indicating the local time and time zone. In addition, time may be used in the context of user requests, such as for instance, to interpret phrases such as “in an hour” and “tonight”.
- Compass, accelerometer, gyroscope, and/or travel velocity data, as well as other sensor data from mobile or handheld devices or embedded systems such as automobile control systems. This may also include device positioning data from remote controls to appliances and game consoles.
- Clicking and menu selection and other events from a graphical user interface (GUI) on any device having a GUI. Further examples include touches to a touch screen.
- Events from sensors and other data-driven triggers, such as alarm clocks, calendar alerts, price change triggers, location triggers, push notification onto a device from servers, and the like.

**[0097]** The input to the embodiments described herein also includes the context of the user interaction history, including dialog and request history.

**[0098]** Examples of different types of output data/information which may be generated by intelligent automated assistant 1002 may include, but are not limited to, one or more of the following (or combinations thereof):

- Text output sent directly to an output device and/or to the user interface of a device
- Text and graphics sent to a user over email
- Text and graphics sent to a user over a messaging service

- Speech output, may include one or more of the following (or combinations thereof):
  - Synthesized speech
  - Sampled speech
  - Recorded messages
- Graphical layout of information with photos, rich text, videos, sounds, and hyperlinks. For instance, the content rendered in a web browser.
- Actuator output to control physical actions on a device, such as causing it to turn on or off, make a sound, change color, vibrate, control a light, or the like.
- Invoking other applications on a device, such as calling a mapping application, voice dialing a telephone, sending an email or instant message, playing media, making entries in calendars, task managers, and note applications, and other applications.
- Actuator output to control physical actions to devices attached or controlled by a device, such as operating a remote camera, controlling a wheelchair, playing music on remote speakers, playing videos on remote displays, and the like.

**[0099]** It may be appreciated that the intelligent automated assistant 1002 of Fig. 1 is but one example from a wide range of intelligent automated assistant system embodiments which may be implemented. Other embodiments of the intelligent automated assistant system (not shown) may include additional, fewer and/or different components/features than those illustrated, for example, in the example intelligent automated assistant system embodiment of Fig. 1.

### ***User Interaction***

**[0100]** Referring now to Fig. 2, there is shown an example of an interaction between a user and at least one embodiment of an intelligent automated assis-



tant 1002. The example of Fig. 2 assumes that a user is speaking to intelligent automated assistant 1002 using input device 1206, which may be a speech input mechanism, and the output is graphical layout to output device 1207, which may be a scrollable screen. Conversation screen 101A features a conversational user interface showing what the user said 101B (“I’d like a romantic place for Italian food near my office”) and assistant’s 1002 response, which is a summary of its findings 101C (“OK, I found these Italian restaurants which reviews say are romantic close to your work:”) and a set of results 101D (the first three of a list of restaurants are shown). In this example, the user clicks on the first result in the list, and the result automatically opens up to reveal more information about the restaurant, shown in information screen 101E. Information screen 101E and conversation screen 101A may appear on the same output device, such as a touchscreen or other display device; the examples depicted in Fig. 2 are two different output states for the same output device.

**[0101]** In one embodiment, information screen 101E shows information gathered and combined from a variety of services, including for example, any or all of the following:

- Addresses and geolocations of businesses;
- Distance from user’s current location;
- Reviews from a plurality of sources;

**[0102]** In one embodiment, information screen 101E also includes some examples of services that assistant 1002 might offer on behalf of the user, including:

- Dial a telephone to call the business (“call”);
- Remember this restaurant for future reference (“save”);
- Send an email to someone with the directions and information about this restaurant (“share”);
- Show the location of and directions to this restaurant on a map (“map it”);

- Save personal notes about this restaurant (“my notes”).

**[0103]** As shown in the example of Fig. 2, in one embodiment, assistant 1002 includes intelligence beyond simple database applications, such as, for example,

- Processing a statement of intent in a natural language 101B, not just keywords;
- Inferring semantic intent from that language input, such as interpreting “place for Italian food” as “Italian restaurants”;
- Operationalizing semantic intent into a strategy for using online services and executing that strategy on behalf of the user (e.g., operationalizing the desire for a romantic place into the strategy of checking online review sites for reviews that describe a place as “romantic”).

### ***Intelligent Automated Assistant Components***

**[0104]** According to various embodiments, intelligent automated assistant 1002 may include a plurality of different types of components, devices, modules, processes, systems, and the like, which, for example, may be implemented and/or instantiated via the use of hardware and/or combinations of hardware and software. For example, as illustrated in the example embodiment of Fig. 1, assistant 1002 may include one or more of the following types of systems, components, devices, processes, and the like (or combinations thereof):

- One or more active ontologies 1050;
- Active input elicitation component(s) 1094 (may include client part 1094a and server part 1094b);
- Short term personal memory component(s) 1052 (may include master version 1052b and cache 1052a);
- Long-term personal memory component(s) 1054 (may include master version 1052b and cache 1052a);

- Domain models component(s) 1056;
- Vocabulary component(s) 1058 (may include complete vocabulary 1058b and subset 1058a);
- Language pattern recognizer(s) component(s) 1060 (may include full library 1060b and subset 1560a);
- Language interpreter component(s) 1070;
- Domain entity database(s) 1072;
- Dialog flow processor component(s) 1080;
- Services orchestration component(s) 1082;
- Services component(s) 1084;
- Task flow models component(s) 1086;
- Dialog flow models component(s) 1087;
- Service models component(s) 1088;
- Output processor component(s) 1090.

**[0105]** As described in connection with Fig. 7, in certain client/server-based embodiments, some or all of these components may be distributed between client 1304 and server 1340.

**[0106]** For purposes of illustration, at least a portion of the different types of components of a specific example embodiment of intelligent automated assistant 1002 will now be described in greater detail with reference to the example intelligent automated assistant 1002 embodiment of Fig. 1.

### ***Active Ontologies 1050***

**[0107]** Active ontologies 1050 serve as a unifying infrastructure that integrates models, components, and/or data from other parts of embodiments of intelligent automated assistants 1002. In the field of computer and information science, ontologies provide structures for data and knowledge representation such as classes/types, relations, attributes/properties and their instantiation in instances. Ontologies are used, for example, to build models of data and knowledge. In some embodiments of the intelligent automated system

1002, ontologies are part of the modeling framework in which to build models such as domain models.

**[0108]** Within the context of the present invention, an “active ontology” 1050 may also serve as an execution environment, in which distinct processing elements are arranged in an ontology-like manner (e.g., having distinct attributes and relations with other processing elements). These processing elements carry out at least some of the tasks of intelligent automated assistant 1002. Any number of active ontologies 1050 can be provided.

**[0109]** In at least one embodiment, active ontologies 1050 may be operable to perform and/or implement various types of functions, operations, actions, and/or other features such as, for example, one or more of the following (or combinations thereof):

- Act as a modeling and development environment, integrating models and data from various model and data components, including but not limited to
  - Domain models 1056
  - Vocabulary 1058
  - Domain entity databases 1072
  - Task flow models 1086
  - Dialog flow models 1087
  - Service capability models 1088
- Act as a data-modeling environment on which ontology-based editing tools may operate to develop new models, data structures, database schemata, and representations.
- Act as a live execution environment, instantiating values for elements of domain 1056, task 1086, and/or dialog models 1087, language pattern recognizers, and/or vocabulary 1058, and user-specific information such as that found in short term personal memory 1052, long term personal memory 1054, and/or the results of service orchestration 1182. For example, some nodes of an active

ontology may correspond to domain concepts such as *restaurant* and its property *restaurant name*. During live execution, these active ontology nodes may be instantiated with the identity of a particular restaurant entity and its name, and how its name corresponds to words in a natural language input utterance. Thus, in this embodiment, the active ontology is serving as both a modeling environment specifying the concept that restaurants are entities with identities that have names, and for storing dynamic bindings of those modeling nodes with data from entity databases and parses of natural language.

- Enable the communication and coordination among components and processing elements of an intelligent automated assistant, such as, for example, one or more of the following (or combinations thereof):
  - Active input elicitation component(s) 1094
  - Language interpreter component(s) 1070
  - Dialog flow processor component(s) 1080
  - Services orchestration component(s) 1082
  - Services component(s) 1084

**[0110]** In one embodiment, at least a portion of the functions, operations, actions, and/or other features of active ontologies 1050 described herein may be implemented, at least in part, using various methods and apparatuses described in U.S. Patent Application Serial No. 11/518,292 for “Method and Apparatus for Building an Intelligent Automated Assistant”, filed September 8, 2006.

**[0111]** In at least one embodiment, a given instance of active ontology 1050 may access and/or utilize information from one or more associated databases. In at least one embodiment, at least a portion of the database information may be accessed via communication with one or more local and/or remote memory devices. Examples of different types of data which may be accessed by

active ontologies 1050 may include, but are not limited to, one or more of the following (or combinations thereof):

- Static data that is available from one or more components of intelligent automated assistant 1002;
- Data that is dynamically instantiated per user session, for example, but not limited to, maintaining the state of the user-specific inputs and outputs exchanged among components of intelligent automated assistant 1002, the contents of short term personal memory, the inferences made from previous states of the user session, and the like.

**[0112]** In this manner, active ontologies 1050 are used to unify elements of various components in intelligent automated assistant 1002. An active ontology 1050 allows an author, designer, or system builder to integrate components so that the elements of one component are identified with elements of other components. The author, designer, or system builder can thus combine and integrate the components more easily.

**[0113]** Referring now to Fig. 8, there is shown an example of a fragment of an active ontology 1050 according to one embodiment. This example is intended to help illustrate some of the various types of functions, operations, actions, and/or other features that may be provided by active ontologies 1050.

**[0114]** Active ontology 1050 in Fig. 8 includes representations of a restaurant and meal event. In this example, a restaurant is a concept 1610 with properties such as its name 1612, cuisines served 1615, and its location 1613, which in turn might be modeled as a structured node with properties for street address 1614. The concept of a meal event might be modeled as a node 1616 including a dining party 1617 (which has a size 1619) and time period 1618.

- Active ontologies may include and/or make reference to domain models 1056. For example, Fig. 8 depicts a dining out domain model 1622 linked to restaurant concept 1610 and meal event con-

cept 1616. In this instance, active ontology 1050 includes dining out domain model 1622; specifically, at least two nodes of active ontology 1050, namely restaurant 1610 and meal event 1616, are also included in and/or referenced by dining out domain model 1622. This domain model represents, among other things, the idea that dining out involves meal event that occur at restaurants. The active ontology nodes restaurant 1610 and meal event 1616 are also included and/or referenced by other components of the intelligent automated assistant, as shown by dotted lines in Fig. 8.

- Active ontologies may include and/or make reference to task flow models 1086. For example, Fig. 8 depicts an event planning task flow model 1630, which models the planning of events independent of domains, applied to a domain-specific kind of event: meal event 1616. Here, active ontology 1050 includes general event planning task flow model 1630, which comprises nodes representing events and other concepts involved in planning them. Active ontology 1050 also includes the node meal event 1616, which is a particular kind of event. In this example, meal event 1616 is included or made reference to by both domain model 1622 and task flow model 1630, and both of these models are included in and/or referenced by active ontology 1050. Again, meal event 1616 is an example of how active ontologies can unify elements of various components included and/or referenced by other components of the intelligent automated assistant, as shown by dotted lines in Fig. 8.
- Active ontologies may include and/or make reference to dialog flow models 1087. For example, Fig. 8 depicts a dialog flow model 1642 for getting the values of constraints required for a transaction instantiated on the constraint party size as represented in concept 1619. Again, active ontology 1050 provides a framework for relating and unifying various components such as dialog flow models

1087. In this case, dialog flow model 1642 has a general concept of a constraint that is instantiated in this particular example to the active ontology node party size 1619. This particular dialog flow model 1642 operates at the abstraction of constraints, independent of domain. Active ontology 1050 represents party size property 1619 of party node 1617, which is related to meal event node 1616. In such an embodiment, intelligent automated assistant 1002 uses active ontology 1050 to unify the concept of constraint in dialog flow model 1642 with the property of party size 1619 as part of a cluster of nodes representing meal event concept 1616, which is part of the domain model 1622 for dining out.

- Active ontologies may include and/or make reference to service models 1088. For example, Fig. 8 depicts a model of a restaurant reservation service 1672 associated with the dialog flow step for getting values required for that service to perform a transaction. In this instance, service model 1672 for a restaurant reservation service specifies that a reservation requires a value for party size 1619 (the number of people sitting at a table to reserve). The concept party size 1619, which is part of active ontology 1050, also is linked or related to a general dialog flow model 1642 for asking the user about the constraints for a transaction; in this instance, the party size is a required constraint for dialog flow model 1642.
- Active ontologies may include and/or make reference to domain entity databases 1072. For example, Fig. 8 depicts a domain entity database of restaurants 1652 associated with restaurant node 1610 in active ontology 1050. Active ontology 1050 represents the general concept of restaurant 1610, as may be used by the various components of intelligent automated assistant 1002, and it is instantiated by data about specific restaurants in restaurant database 1652.



- Active ontologies may include and/or make reference to vocabulary databases 1058. For example, Fig. 8 depicts a vocabulary database of cuisines 1662, such as Italian, French, and the like, and the words associated with each cuisine such as “French”, “continental”, “provincial”, and the like. Active ontology 1050 includes restaurant node 1610, which is related to cuisines served node 1615, which is associated with the representation of cuisines in cuisines database 1662. A specific entry in database 1662 for a cuisine, such as “French”, is thus related through active ontology 1050 as an instance of the concept of cuisines served 1615.
- Active ontologies may include and/or make reference to any database that can be mapped to concepts or other representations in ontology 1050. Domain entity databases 1072 and vocabulary databases 1058 are merely two examples of how active ontology 1050 may integrate databases with each other and with other components of automated assistant 1002. Active ontologies allow the author, designer, or system builder to specify a nontrivial mapping between representations in the database and representations in ontology 1050. For example, the database schema for restaurants database 1652 may represent a restaurant as a table of strings and numbers, or as a projection from a larger database of business, or any other representation suitable for database 1652. In this example active ontology 1050, restaurant 1610 is a concept node with properties and relations, organized differently from the database tables. In this example, nodes of ontology 1050 are associated with elements of database schemata. The integration of database and ontology 1050 provides a unified representation for interpreting and acting on specific data entries in databases in terms of the larger sets of models and data in active ontology 1050. For instance, the word “French” may be an entry in cuisines database 1662. Because, in

this example, database 1662 is integrated in active ontology 1050, that same word “French” also has an interpretation as a possible cuisine served at a restaurant, which is involved in planning meal events, and this cuisine serves as a constraint to use when using restaurants reservation services, and so forth. Active ontologies can thus integrate databases into the modeling and execution environment to inter-operate with other components of automated assistant 1002.

**[0115]** As described above, active ontology 1050 allows the author, designer, or system builder to integrate components; thus, in the example of Fig. 8, the elements of a component such as constraint in dialog flow model 1642 can be identified with elements of other components such as required parameter of restaurant reservation service 1672.

**[0116]** Active ontologies 1050 may be embodied as, for example, configurations of models, databases, and components in which the relationships among models, databases, and components are any of:

- containership and/or inclusion;
- relationship with links and/or pointers;
- interface over APIs, both internal to a program and between programs.

**[0117]** For example, referring now to Fig. 9, there is shown an example of an alternative embodiment of intelligent automated assistant system 1002, wherein domain models 1056, vocabulary 1058, language pattern recognizers 1060, short term personal memory 1052, and long term personal memory 1054 components are organized under a common container associated with active ontology 1050, and other components such as active input elicitation component(s) 1094, language interpreter 1070 and dialog flow processor 1080 are associated with active ontology 1050 via API relationships.

**Active Input Elicitation Component(s) 1094**

**[0118]** In at least one embodiment, active input elicitation component(s) 1094 (which, as described above, may be implemented in a stand-alone configuration or in a configuration including both server and client components) may be operable to perform and/or implement various types of functions, operations, actions, and/or other features such as, for example, one or more of the following (or combinations thereof):

- Elicit, facilitate and/or process input from the user or the user's environment, and/or information about their need(s) or request(s). For example, if the user is looking to find a restaurant, the input elicitation module may get information about the user's constraints or preferences for location, time, cuisine, price, and so forth.
- Facilitate different kinds of input from various sources, such as for example, one or more of the following (or combinations thereof):
  - input from keyboards or any other input device that generates text
  - input from keyboards in user interfaces that offer dynamic suggested completions of partial input
  - input from voice or speech input systems
  - input from Graphical User Interfaces (GUIs) in which users click, select, or otherwise directly manipulate graphical objects to indicate choices
  - input from other applications that generate text and send it to the automated assistant, including email, text messaging, or other text communication platforms

**[0119]** By performing active input elicitation, assistant 1002 is able to disambiguate intent at an early phase of input processing. For example, in an embodiment where input is provided by speech, the waveform might be sent to a server 1340 where words are extracted, and semantic interpretation performed. The results of such semantic interpretation can then be used to drive

active input elicitation, which may offer the user alternative candidate words to choose among based on their degree of *semantic* fit as well as phonetic match.

**[0120]** In at least one embodiment, active input elicitation component(s) 1094 actively, automatically, and dynamically guide the user toward inputs that may be acted upon by one or more of the services offered by embodiments of assistant 1002. Referring now to Fig. 10, there is shown a flow diagram depicting a method of operation for active input elicitation component(s) 1094 according to one embodiment.

**[0121]** The procedure begins 20. In step 21, assistant 1002 may offer interfaces on one or more input channels. For example, a user interface may offer the user options to speak or type or tap at any stage of a conversational interaction. In step 22, the user selects an input channel by initiating input on one modality, such as pressing a button to start recording speech or to bring up an interface for typing.

**[0122]** In at least one embodiment, assistant 1002 offers default suggestions for the selected modality 23. That is, it offers options 24 that are relevant in the current context prior to the user entering any input on that modality. For example, in a text input modality, assistant 1002 might offer a list of common words that would begin textual requests or commands such as, for example, one or more of the following (or combinations thereof): imperative verbs (e.g., find, buy, reserve, get, call, check, schedule, and the like), nouns (e.g., restaurants, movies, events, businesses, and the like), or menu-like options naming domains of discourse (e.g., weather, sports, news, and the like)

**[0123]** If the user selects one of the default options in 25, and a preference to autosubmit 30 is set, the procedure may return immediately. This is similar to the operation of a conventional menu selection.

**[0124]** However, the initial option may be taken as a partial input, or the user may have started to enter a partial input 26. At any point of input, in at

least one embodiment, the user may choose to indicate that the partial input is complete 22, which causes the procedure to return.

**[0125]** In 28, the latest input, whether selected or entered, is added to the cumulative input.

**[0126]** In 29, the system suggestions next possible inputs that are relevant given the current input and other sources of constraints on what constitutes relevant and/or meaningful input.

**[0127]** In at least one embodiment, the sources of constraints on user input (for example, which are used in steps 23 and 29) are one or more of the various models and data sources that may be included in assistant 1002, which may include, but are not limited to, one or more of the following (or combinations thereof):

- Vocabulary 1058. For example, words or phrases that match the current input may be suggested. In at least one embodiment, vocabulary may be associated with any or one or more nodes of active ontologies, domain models, task models, dialog models, and/or service models.
- Domain models 1056, which may constrain the inputs that may instantiate or otherwise be consistent with the domain model. For example, in at least one embodiment, domain models 1056 may be used to suggest concepts, relations, properties, and/or instances that would be consistent with the current input.
- Language pattern recognizers 1060, which may be used to recognize idioms, phrases, grammatical constructs, or other patterns in the current input and be used to suggest completions that fill out the pattern.
- Domain entity databases 1072, which may be used to suggest possible entities in the domain that match the input (e.g., business names, movie names, event names, and the like).

- Short term memory 1052, which may be used to match any prior input or portion of prior input, and/or any other property or fact about the history of interaction with a user. For example, partial input may be matched against cities that the user has encountered in a session, whether hypothetically (e.g., mentioned in queries) and/or physically (e.g., as determined from location sensors).
- In at least one embodiment, semantic paraphrases of recent inputs, request, or results may be matched against the current input. For example, if the user had previously request “live music” and obtained concert listing, and then typed “music” in an active input elicitation environment, suggestions may include “live music” and/or “concerts”.
- Long term personal memory 1054, which may be used to suggest matching items from long term memory. Such matching items may include, for example, one or more or any combination of: domain entities that are saved (e.g., “favorite” restaurants, movies, theaters, venues, and the like), to-do items, list items, calendar entries, people names in contacts/address books, street or city names mentioned in contact/address books, and the like.
- Task flow models 1086, which may be used to suggest inputs based on the next possible steps of in a task flow.
- Dialog flow models 1087, which may be used to suggest inputs based on the next possible steps of in a dialog flow.
- Service capability models 1088, which may be used to suggest possible services to employ, by name, category, capability, or any other property in the model. For example, a user may type part of the name of a preferred review site, and assistant 1002 may suggest a complete command for querying that review site for review.

**[0128]** In at least one embodiment, active input elicitation component(s) 1094 present to the user a conversational interface, for example, an interface in

which the user and assistant communicate by making utterances back and forth in a conversational manner. Active input elicitation component(s) 1094 may be operable to perform and/or implement various types of conversational interfaces.

**[0129]** In at least one embodiment, active input elicitation component(s) 1094 may be operable to perform and/or implement various types of conversational interfaces in which assistant 1002 uses plies of the conversation to prompt for information from the user according to dialog models. Dialog models may represent a procedure for executing a dialog, such as, for example, a series of steps required to elicit the information needed to perform a service.

**[0130]** In at least one embodiment, active input elicitation component(s) 1094 offer constraints and guidance to the user in real time, while the user is in the midst of typing, speaking, or otherwise creating input. For example, active elicitation may guide the user to type text inputs that are recognizable by an embodiment of assistant 1002 and/or that may be serviced by one or more services offered by embodiments of assistant 1002. This is an advantage over passively waiting for unconstrained input from a user because it enables the user's efforts to be focused on inputs that may or might be useful, and/or it enables embodiments of assistant 1002 to apply its interpretations of the input in real time as the user is inputting it.

**[0131]** At least a portion of the functions, operations, actions, and/or other features of active input elicitation described herein may be implemented, at least in part, using various methods and apparatuses described in published U.S. Patent Application US 2007/0100790 A1 for "Method and Apparatus for Building an Intelligent Automated Assistant".

**[0132]** According to specific embodiments, multiple instances or threads of active input elicitation component(s) 1094 may be concurrently implemented and/or initiated via the use of one or more processors 63 and/or other combinations of hardware and/or hardware and software.

**[0133]** According to different embodiments, one or more different threads or instances of active input elicitation component(s) 1094 may be initiated in response to detection of one or more conditions or events satisfying one or more different types of minimum threshold criteria for triggering initiation of at least one instance of active input elicitation component(s) 1094. Various examples of conditions or events which may trigger initiation and/or implementation of one or more different threads or instances of active input elicitation component(s) 1094 may include, but are not limited to, one or more of the following (or combinations thereof):

- Start of user session. For example, when the user session starts up an application that is an embodiment of assistant 1002, the interface may offer the opportunity for the user to initiate input, for example, by pressing a button to initiate a speech input system or clicking on a text field to initiate a text input session.
- User input detected.
- When assistant 1002 explicitly prompts the user for input, as when it requests a response to a question or offers a menu of next steps from which to choose.
- When assistant 1002 is helping the user perform a transaction and is gathering data for that transaction, e.g., filling in a form.

**[0134]** In at least one embodiment, a given instance of active input elicitation component(s) 1094 may access and/or utilize information from one or more associated databases. In at least one embodiment, at least a portion of the database information may be accessed via communication with one or more local and/or remote memory devices. Examples of different types of data which may be accessed by active input elicitation component(s) 1094 may include, but are not limited to, one or more of the following (or combinations thereof):

- database of possible words to use in a textual input;
- grammar of possible phrases to use in a textual input utterance;



- database of possible interpretations of speech input;
- database of previous inputs from a user or from other users;
- data from any of the various models and data sources that may be part of embodiments of assistant 1002, which may include, but are not limited to, one or more of the following (or combinations thereof):
  - Domain models 1056;
  - Vocabulary 1058;
  - Language pattern recognizers 1060;
  - Domain entity databases 1072;
  - Short term memory 1052;
  - Long term personal memory 1054;
  - Task flow models 1086;
  - Dialog flow models 1087;
  - Service capability models 1088.

**[0135]** According to different embodiments, active input elicitation component(s) 1094 may apply active elicitation procedures to, for example, one or more of the following (or combinations thereof):

- typed input;
- speech input;
- input from graphical user interfaces (GUIs), including gestures;
- input from suggestions offered in a dialog; and
- events from the computational and/or sensed environments.

#### *Active Typed Input Elicitation*

**[0136]** Referring now to Fig. 11, there is shown a flow diagram depicting a method for active typed input elicitation according to one embodiment.

**[0137]** The method begins 110. Assistant 1002 receives 111 partial text input, for example via input device 1206. Partial text input may include, for example, the characters that have been typed so far in a text input field. At any

time, a user may indicate that the typed input is complete 112, as, for example, by pressing an Enter key. If not complete, a suggestion generator generates 114 candidate suggestions 116. These suggestions may be syntactic, semantic, and/or other kinds of suggestion based any of the sources of information or constraints described herein. If the suggestion is selected 118, the input is transformed 117 to include the selected suggestion.

**[0138]** In at least one embodiment, the suggestions may include extensions to the current input. For example, a suggestion for “rest” may be “restaurants”.

**[0139]** In at least one embodiment, the suggestions may include replacements of parts of the current input. For example, a suggestion for “rest” may be “places to eat”.

**[0140]** In at least one embodiment, the suggestions may include replacing and rephrasing of parts of the current input. For example, if the current input is “find restaurants of style” a suggestion may be “italian” and when the suggestion is chosen, the entire input may be rewritten as “find Italian restaurants”.

**[0141]** In at least one embodiment, the resulting input that is returned is annotated 119, so that information about which choices were made in 118 is preserved along with the textual input. This enables, for example, the semantic concepts or entities underlying a string to be associated with the string when it is returned, which improves accuracy of subsequent language interpretation.

**[0142]** Referring now to Figs. 12 to 21, there are shown screen shots illustrating some portions of some of the procedures for active typed-input elicitation according to one embodiment. The screen shots depict an example of an embodiment of assistant 1002 as implemented on a smartphone such as the iPhone available from Apple Inc. of Cupertino, California. Input is provided to such device via a touchscreen, including on-screen keyboard functionality. One skilled in the art will recognize that the screen shots depict an embodi-

ment that is merely exemplary, and that the techniques of the present invention can be implemented on other devices and using other layouts and arrangements.

**[0143]** In Fig. 12, screen 1201 includes a top-level set of suggestions 1202 shown when no input has been provided in field 1203. This corresponds to no-input step 23 of Fig. 10 applied to step 114 of Fig. 11 where there is no input.

**[0144]** In Fig. 13, screen 1301 depicts an example of the use of vocabulary to offer suggested completions 1303 of partial user input 1305 entered in field 1203 using on-screen keyboard 1304. These suggested completions 1303 may be part of the function of active input elicitation 1094. The user has entered partial user input 1305 including the string “comm”. Vocabulary component 1058 has provided a mapping of this string into three different kinds of instances, which are listed as suggested completions 1303: the phrase “community & local events” is a category of the events domain; “chambers of commerce” is a category of the local business search domain, and “Jewish Community Center” is the name of an instance of local businesses. Vocabulary component 1058 may provide the data lookup and management of name spaces like these. The user can tap Go button 1306 to indicate that he or she has finished entering input; this causes assistant 1002 to proceed with the completed text string as a unit of user input.

**[0145]** In Fig. 14, screen 1401 depicts an example in which suggested semantic completions 1303 for a partial string “wh” 1305 include entire phrases with typed parameters. These kinds of suggestions may be enabled by the use of one or more of the various models and sources of input constraints described herein. For example, in one embodiment shown in Fig. 14, “what is happening *in city*” is an active elicitation of the location parameter of the Local Events domain; “where is *business name*” is an active elicitation of the Business Name constraint of the Local Business Search domain; “what is showing at the *venue name*” is an active elicitation of the Venue Name con-

straint of the Local Events domain; and “what is playing at the *movie theater*” is an active elicitation of the Movie Theater Name constraint of the Local Events domain. These examples illustrate that the suggested completions are *generated by models* rather than simply drawn from a database of previously entered queries.

**[0146]** In Fig. 15, screen 1501 depicts a continuation of the same example, after the user has entered additional text 1305 in field 1203. Suggested completions 1303 are updated to match the additional text 1305. In this example, data from a domain entity database 1072 were used: venues whose name starts with “f”. Note that this is a significantly smaller and more semantically relevant set of suggestions than all words that begin with “f”. Again, the suggestions are generated by applying a model, in this case the domain model that represents Local Events as happening at Venues, which are Businesses with Names. The suggestions *actively elicit* inputs that would make potentially meaningful entries when using a Local Events service.

**[0147]** In Fig. 16, screen 1601 depicts a continuation of the same example, after the user has selected one of suggested completions 1303. Active elicitation continues by prompting the user to further specify the type of information desired, here by presenting a number of specifiers 1602 from which the user can select. In this example, these specifiers are generated by the domain, task flow, and dialog flow models. The Domain is Local Events, which includes Categories of events that happen on Dates in Locations and have Event Names and Feature Performers. In this embodiment, the fact that these five options are offered to the user is generated from the Dialog Flow model that indicates that users should be asked for Constraints that they have not yet entered and from the Service Model that indicates that these five Constraints are parameters to Local Event services available to the assistant. Even the choice of preferred phrases to use as specifiers, such as “by category” and “featured”, are generated from the Domain Vocabulary databases.

**[0148]** In Fig. 17, screen 1701 depicts a continuation of the same example, after the user has selected one of specifiers 1602.

**[0149]** In Fig. 18, screen 1801 depicts a continuation of the same example, wherein the selected specifier 1602 has been added to field 1203, and additional specifiers 1602 are presented. The user can select one of specifiers 1602 and/or provide additional text input via keyboard 1304.

**[0150]** In Fig. 19, screen 1901 depicts a continuation of the same example, wherein the selected specifier 1602 has been added to field 1203, and yet more specifiers 1602 are presented. In this example, previously entered constraints are not actively elicited redundantly.

**[0151]** In Fig. 20, screen 2001 depicts a continuation of the same example, wherein the user has tapped the Go button 1306. The user's input is shown in box 2002, and a message is shown in box 2003, providing feedback to the user as to the query being performed in response to the user's input.

**[0152]** In Fig. 21, screen 2101 depicts a continuation of the same example, wherein results have been found. Message is shown in box 2102. Results 2103, including input elements allowing the user to view further details, save the identified event, buy tickets, add notes, or the like.

**[0153]** In one screen 2101, and other displayed screens, are scrollable, allowing the user to scroll upwards to see screen 2001 or other previously presented screens, and to make changes to the query if desired.

### *Active Speech Input Elicitation*

**[0154]** Referring now to Fig. 22, there is shown a flow diagram depicting a method for active input elicitation for voice or speech input according to one embodiment.

**[0155]** The method begins 221. Assistant 1002 receives 121 voice or speech input in the form of an auditory signal. A speech-to-text service 122 or processor generates a set of candidate text interpretations 124 of the auditory signal. In one embodiment, speech-to-text service 122 is implemented using, for

example, Nuance Recognizer, available from Nuance Communications, Inc. of Burlington, MA.

**[0156]** In one embodiment, assistant 1002 employs statistical language models to generate candidate text interpretations 124 of speech input 121.

**[0157]** In addition, in one embodiment, the statistical language models are tuned to look for words, names, and phrases that occur in the various models of assistant 1002 shown in Fig. 8. For example, in at least one embodiment the statistical language models are given words, names, and phrases from some or all of: domain models 1056 (e.g., words and phrases relating to restaurant and meal events), task flow models 1086 (e.g., words and phrases relating to planning an event), dialog flow models 1087 (e.g., words and phrases related to the constraints that are needed to gather the inputs for a restaurant reservation), domain entity databases 1072 (e.g., names of restaurants), vocabulary databases 1058 (e.g., names of cuisines), service models 1088 (e.g., names of service providers such as OpenTable), and/or any words, names, or phrases associated with any node of active ontology 1050.

**[0158]** In one embodiment, the statistical language models are also tuned to look for words, names, and phrases from long-term personal memory 1054. For example, statistical language models can be given text from to-do items, list items, personal notes, calendar entries, people names in contacts/address books, email addresses, street or city names mentioned in contact/address books, and the like.

**[0159]** A ranking component analyzes the candidate interpretations 124 and ranks 126 them according to how well they fit syntactic and/or semantic models of intelligent automated assistant 1002. Any sources of constraints on user input may be used. For example, in one embodiment, assistant 1002 may rank the output of the speech-to-text interpreter according to how well the interpretations parse in a syntactic and/or semantic sense, a domain model, task flow model, and/or dialog model, and/or the like: it evaluates how well various combinations of words in the text interpretations 124 would fit the

concepts, relations, entities, and properties of active ontology 1050 and its associated models. For example, if speech-to-text service 122 generates the two candidate interpretations “italian food for lunch” and “italian shoes for lunch”, the ranking by semantic relevance 126 might rank “italian food for lunch” higher if it better matches the nodes assistant’s 1002 active ontology 1050 (e.g., the words “italian”, “food” and “lunch” all match nodes in ontology 1050 and they are all connected by relationships in ontology 1050, whereas the word “shoes” does not match ontology 1050 or matches a node that is not part of the dining out domain network).

**[0160]** In various embodiments, algorithms or procedures used by assistant 1002 for interpretation of text inputs, including any embodiment of the natural language processing procedure shown in Fig. 28, can be used to rank and score candidate text interpretations 124 generated by speech-to-text service 122.

**[0161]** In one embodiment, if ranking component 126 determines 128 that the highest-ranking speech interpretation from interpretations 124 ranks above a specified threshold, the highest-ranking interpretation may be automatically selected 130. If no interpretation ranks above a specified threshold, possible candidate interpretations of speech 134 are presented 132 to the user. The user can then select 136 among the displayed choices.

**[0162]** In various embodiments, user selection 136 among the displayed choices can be achieved by any mode of input, including for example any of the modes of multimodal input described in connection with Fig. 16. Such input modes include, without limitation, actively elicited typed input 2610, actively elicited speech input 2620, actively presented GUI for input 2640, and/or the like. In one embodiment, the user can select among candidate interpretations 134, for example by tapping or speaking. In the case of speaking, the possible interpretation of the new speech input is highly constrained by the small set of choices offered 134. For example, if offered “Did you mean italian food or italian shoes?” the user can just say “food” and the assistant

can match this to the phrase “italian food” and not get it confused with other global interpretations of the input.

**[0163]** Whether input is automatically selected 130 or selected 136 by the user, the resulting input 138 is returned. In at least one embodiment, the returned input is annotated 138, so that information about which choices were made in step 136 is preserved along with the textual input. This enables, for example, the semantic concepts or entities underlying a string to be associated with the string when it is returned, which improves accuracy of subsequent language interpretation. For example, if “Italian food” was offered as one of the candidate interpretations 134 based on a semantic interpretation of *Cuisine=ItalianFood*, then the machine-readable semantic interpretation can be sent along with the user’s selection of the string “Italian food” as annotated text input 138.

**[0164]** In at least one embodiment, candidate text interpretations 124 are generated based on speech interpretations received as output of speech-to-text service 122.

**[0165]** In at least one embodiment, candidate text interpretations 124 are generated by paraphrasing speech interpretations in terms of their semantic meaning. In some embodiments, there can be multiple paraphrases of the same speech interpretation, offering different word sense or homonym alternatives. For example, if speech-to-text service 122 indicates “place for meet”, the candidate interpretations presented to the user could be paraphrased as “place to meet (local businesses)” and “place for meat (restaurants)”.

**[0166]** In at least one embodiment, candidate text interpretations 124 include offers to correct substrings.

**[0167]** In at least one embodiment, candidate text interpretations 124 include offers to correct substrings of candidate interpretations using syntactic and semantic analysis as described herein.

**[0168]** In at least one embodiment, when the user selects a candidate interpretation, it is returned.



**[0169]** In at least one embodiment, the user is offered an interface to edit the interpretation before it is returned.

**[0170]** In at least one embodiment, the user is offered an interface to continue with more voice input before input is returned. This enables one to incrementally build up an input utterance, getting syntactic and semantic corrections, suggestions, and guidance at one iteration.

**[0171]** In at least one embodiment, the user is offered an interface to proceed directly from 136 to step 111 of a method of active typed input elicitation (described above in connection with Fig. 11). This enables one to interleave typed and spoken input, getting syntactic and semantic corrections, suggestions, and guidance at one step.

**[0172]** In at least one embodiment, the user is offered an interface to proceed directly from step 111 of an embodiment of active typed input elicitation to an embodiment of active speech input elicitation. This enables one to interleave typed and spoken input, getting syntactic and semantic corrections, suggestions, and guidance at one step.

#### *Active GUI-based Input Elicitation*

**[0173]** Referring now to Fig. 23, there is shown a flow diagram depicting a method for active input elicitation for GUI-based input according to one embodiment.

**[0174]** The method begins 140. Assistant 1002 presents 141 graphical user interface (GUI) on output device 1207, which may include, for example, links and buttons. The user interacts 142 with at least one GUI element. Data 144 is received, and converted 146 to a uniform format. The converted data is then returned.

**[0175]** In at least one embodiment, some of the elements of the GUI are generated dynamically from the models of the active ontology, rather than written into a computer program. For example, assistant 1002 can offer a set of constraints to guide a restaurant reservation service as regions for tapping on a screen, with each region representing the name of the constraint and/or

a value. For instance, the screen could have rows of a dynamically generated GUI layout with regions for the constraints Cuisine, Location, and Price Range. If the models of the active ontology change, the GUI screen would automatically change without reprogramming.

*Active Dialog Suggestion Input Elicitation*

**[0176]** Fig. 24 is a flow diagram depicting a method for active input elicitation at the level of a dialog flow according to one embodiment. Assistant 1002 suggests 151 possible responses 152. The user selects 154 a suggested response. The received input is converted 154 to a uniform format. The converted data is then returned.

**[0177]** In at least one embodiment, the suggestions offered in step 151 are offered as follow-up steps in a dialog and/or task flow.

**[0178]** In at least one embodiment, the suggestions offer options to refine a query, for example using parameters from a domain and/or task model. For example, one may be offered to change the assumed location or time of a request.

**[0179]** In at least one embodiment, the suggestions offer options to choose among ambiguous alternative interpretations given by a language interpretation procedure or component.

**[0180]** In at least one embodiment, the suggestions offer options to choose among ambiguous alternative interpretations given by a language interpretation procedure or component.

**[0181]** In at least one embodiment, the suggestions offer options to choose among next steps in a workflow associated dialog flow model 1087. For example, dialog flow model 1087 may suggest that after gathering the constrained for one domain (e.g., restaurant dining), assistant 1002 should suggest other related domains (e.g., a movie nearby).

*Active Monitoring for Relevant Events*

**[0182]** In at least one embodiment, asynchronous events may be treated as inputs in an analogous manner to the other modalities of active elicited input. Thus, such events may be provided as inputs to assistant 1002. Once interpreted, such events can be treated in a manner similar to any other input.

**[0183]** For example, a flight status change may initiate an alert notification to be sent to a user. If a flight is indicated as being late, assistant 1002 may continue the dialog by presenting alternative flights, making other suggestions, and the like, based on the detected event.

**[0184]** Such events can be of any type. For example, assistant 1002 might detect that the user just got home, or is lost (off a specified route), or that a stock price hit a threshold value, or that a television show the user is interested in is starting, or that a musician of interest is touring in the area. In any of these situations, assistant 1002 can proceed with a dialog in substantially the same manner as if the user had him- or herself initiated the inquiry. In one embodiment, events can even be based on data provided from other devices, for example to tell the user when a coworker has returned from lunch (the coworker's device can signal such an event to the user's device, at which time assistant 1002 installed on the user's device responds accordingly).

**[0185]** In one embodiment, the events can be notifications or alerts from a calendar, clock, reminder, or to-do application. For example, an alert from a calendar application about a dinner date can initiate a dialog with assistant 1002 about the dining event. The dialog can proceed as if the user had just spoken or typed the information about the upcoming dinner event, such as "dinner for 2 in San Francisco".

**[0186]** In one embodiment, the context of possible event trigger 162 can include information about people, places, times, and other data. These data can be used as part of the input to assistant 1002 to use in various steps of processing.

**[0187]** In one embodiment, these data from the context of event trigger 162 can be used to disambiguate speech or text inputs from the user. For example, if a calendar event alert includes the name of a person invited to the event, that information can help disambiguate input which might match several people with the same or similar name.

**[0188]** Referring now to Fig. 25, there is shown a flow diagram depicting a method for active monitoring for relevant events according to one embodiment. In this example, event trigger events are sets of input 162. Assistant 1002 monitors 161 for such events. Detected events may be filtered and sorted 164 for semantic relevance using models, data and information available from other components in intelligent automated assistant 1002. For example, an event that reports a change in flight status may be given higher relevance if the short-term or long-term memory records for a user indicate that the user is on that flight and/or have made inquiries about it to assistant 1002. This sorting and filtering may then present only the top events for review by the user, who may then choose to pick one or more and act on them.

**[0189]** Event data is converted 166 to a uniform input format, and returned.

**[0190]** In at least one embodiment, assistant 1002 may proactively offer services associated with events that were suggested for user attention. For example, if a flight status alert indicates a flight may be missed, assistant 1002 may suggest to the user a task flow for re-planning the itinerary or booking a hotel.

*Input Elicitation Component(s) Example:*

**[0191]** The following example is intended to help illustrate some of the various types of functions, operations, actions, and/or other features which may be provided by active input elicitation component(s) 1094.

**Example: Command completion (what can the user say to assistant 1002?)**

**[0192]** The user is facing a text input box with the general instruction to enter “what do you want to do?” Depending on the context and the user in-

put, any of several system responses are provided. Examples are shown below

**Case: Null input**

User Input	System Response	Comment
With an empty field and no dialog context, type a question or space character, or enter nothing for some period of time. 	<ul style="list-style-type: none"> <li>• Find restaurants, hotels, movies, ...</li> <li>• Book a table, a room, a seat, ...</li> <li>• Order food, flowers, ...</li> <li>• Buy a ticket, a book, a DVD, ...</li> <li>• Schedule a meeting, an event, ...</li> <li>• Remember to a thing to do...</li> <li>• Explain results</li> </ul>	Black text would be inserted into the input field. Italicized text would be the follow-up suggestions once the text was inserted.

**Case: First word input**

User Input	System Response	Comment
With empty dialog context If the user types the first letter of any command, it is suggested. For example F	<ul style="list-style-type: none"> <li>• <u>F</u>ind restaurants, hotels, movies, ...</li> <li>•</li> </ul>	Black text would be inserted into the input field. Italicized text would be the follow-up suggestions once the text was inserted.

**Case: Key word input**

User Input	System Response	Comment
With empty dialog context If the user types the first two letters of any keyword, it	<ul style="list-style-type: none"> <li>• <u>Re</u>member to a thing to do...</li> <li>• Find <u>re</u>staurants by location, cuisine,</li> <li>•</li> </ul>	Black text would be inserted into the input field. Italicized text would be the

is suggested as well as command. For example Re		follow-up suggestions once the text was inserted.
----------------------------------------------------	--	---------------------------------------------------

**Case: Prompting for arguments**

User Input	System Response	Comment
The user has entered or selected a "command" verb and nothing else. For example, Find_	<ul style="list-style-type: none"> <li>• restaurants by location, cuisine, ...</li> <li>• hotels by location, availability, ...</li> <li>• movies by location, genre, ...</li> <li>• name of place</li> </ul>	Offer not only the selection class but advertise the constraint options. Note that name of place is a just a prompt, and would not insert text.

**Case: Suggesting criteria**

User Input	System Response	Comment
The user has already entered enough to establish a task and domain, and now is prompted for constraints in order. Find restaurants_	<ul style="list-style-type: none"> <li>• in city, zip code</li> <li>• near home, office, place name</li> <li>• named restaurant name</li> <li>•</li> </ul>	Black text would be inserted into the input field. Italicized text would be the follow-up suggestions once the text was inserted.

**Case: Adding criteria**

User Input	System Response	Comment
The user has said "in" and now is prompted for locations	<ul style="list-style-type: none"> <li>• city, zip code</li> <li>• Palo Alto, CA</li> </ul>	Until they enter the next word, the suggestions are a

Find restaurants in_	<ul style="list-style-type: none"> <li>• Menlo Park, CA</li> </ul>	prompt for what kind of thing to type. The Places are cities from personal memory.
The user has said "near" and now is prompted for locations Find restaurants near_	<ul style="list-style-type: none"> <li>• my home</li> <li>• my work</li> <li>• Palo Alto, CA</li> <li>• Menlo Park, CA</li> </ul>	The Places are one or more places from personal memory.

#### Case: Adding location or other constraints

User Input	System Response	Comment
Find restaurants in Palo Alto_	<ul style="list-style-type: none"> <li>• serving food type or cuisine</li> <li>• with availability tonight, tomorrow, ...</li> <li>• described as romantic, good service</li> </ul>	Prompt for other constraints
Find restaurants in Palo Alto with availability_	<ul style="list-style-type: none"> <li>• tonight</li> <li>• tomorrow</li> <li>• at 7pm</li> <li>• at 9pm</li> <li>• other time or date</li> </ul>	The 7:00 and 9:00 are our suggestions based on current time

#### Case: Starting from constraint, unknown task or domain

User Input	System Response	Comment
romantic _	<ul style="list-style-type: none"> <li>• restaurants by location, cuisine, ...</li> <li>• hotels by location, availability, ...</li> <li>• movies by location, genre, ...</li> </ul>	Constraint value from ontology tells you which selection classes to use.

	•	
comedy_	<ul style="list-style-type: none"> <li>• movies by location, genre, ...</li> <li>• events by location, ...</li> <li>• clubs by location</li> </ul>	<p>“comedy” is a constraint value for genre in movies, a genre in events, and “comedy clubs” is a local directory business category</p>

### Example: Name completion

**[0193]** Here, the user has typed some text without accepting any of the commands, or he or she is just extending a command with an entity name. The system may attempt to complete the names, depending on context. It also disambiguates the domain.

### Case: words without context

User Input	System Response	Comment
il for	<ul style="list-style-type: none"> <li>• Il Fornaio (restaurant)</li> <li>• Ill Forgotten Gains (movie)</li> </ul>	May require entity name lookup. Notice multi-word completion. Show domain as a suggestion.
tom cruise	<ul style="list-style-type: none"> <li>• movies</li> </ul>	May require entity name lookup.
romantic	<ul style="list-style-type: none"> <li>• movies</li> <li>• restaurants</li> </ul>	Based on ontology only

### Case: name with context

User Input	System Response	Comment
Find restaurants il for	<ul style="list-style-type: none"> <li>• Il Fornaio (restaurant)</li> <li>•</li> </ul>	May require entity name lookup. Uses selection class and location context from current and past queries to con-



		strain completion. Show domain as a suggestion.
tom cruise	<ul style="list-style-type: none"> <li>• movies</li> </ul>	May require entity name lookup.
Find movies rom	<ul style="list-style-type: none"> <li>• romantic</li> <li>• Roman Holiday (movie)</li> </ul>	Based on ontology only
g-rated	<ul style="list-style-type: none"> <li>• movies</li> </ul>	

#### Example: Choosing values from a set

**[0194]** Here, the user is responding to a system request to enter a value for a specific parameter, such as location, time, cuisine, or genre. The user may either select from a list or enter a value. As she types, matching items from the list are shown as options. Examples are shown below.

#### Case: valueclass selection

User Input	System Response	Comment
Restaurants serving	<ul style="list-style-type: none"> <li>• burgers</li> <li>• Ice cream</li> <li>• Hot dogs</li> </ul>	User may type anything else and doesn't have to pick from the menu.
Restaurants serving h	<ul style="list-style-type: none"> <li>• Hamburgers</li> <li>• Hot dogs</li> <li>• Hot sauce</li> </ul>	
Movies playing	<ul style="list-style-type: none"> <li>• today</li> <li>• tonight</li> <li>• Friday night</li> </ul>	

#### Example: Reusing previous commands

**[0195]** Previous queries are also options to complete on in an autocomplete interface. They may be just matched as strings (when the input field is empty

and there are no known constraints) or they may be suggested as relevant when in certain situations.

**Case: completion on previous queries**

User Input	System Response	Comment
Ital	<ul style="list-style-type: none"> <li>• <u>Italian</u> restaurants (normal completion)</li> <li>• Films starring <u>Italian</u> actors (recent query)</li> </ul>	Using string matching to retrieve previous queries
Lunch	<ul style="list-style-type: none"> <li>• lunch places in marin (recent query)</li> <li>• buy the book naked lunch</li> </ul>	

**Example: Retrieving Personal Memory items**

**[0196]** Assistant 1002 may remember certain events and/or entities in personal memory associated with the user. Autocomplete can be performed based on such remembered items. Examples appear below.

**Case: completion on events and entities in personal memory**

User Input	System Response	Comment
Mary	<ul style="list-style-type: none"> <li>• lunch with <u>Mary</u> on Saturday (from My Events)</li> <li>• films called "Something about <u>Mary</u>"</li> </ul>	
Lunch	<ul style="list-style-type: none"> <li>• lunch with <u>Mary</u> on Saturday (from My Events)</li> <li>• buy the book naked lunch (from My Todos)</li> </ul>	
Hob	<ul style="list-style-type: none"> <li>• Hobee's Restaurant in Palo Alto (from My Restaurants)</li> </ul>	

*Multimodal Active Input Elicitation*

**[0197]** In at least one embodiment, active input elicitation component(s) 1094 may process input from a plurality of input modalities. At least one modality might be implemented with an active input elicitation procedure that takes advantages of the particular kinds of inputs and methods for selecting from suggested options. As described herein, they may be embodiments of procedures for active input elicitation for text input, speech input, GUI-based input, input in the context of a dialog, and/or input resulting from event triggers.

**[0198]** In at least one embodiment, for a single instance of intelligent automated assistant 1002, there may be support for one or more (or any combination of) typed input, speech input, GUI input, dialog input, and/or event input.

**[0199]** Referring now to Fig. 26, there is shown a flow diagram depicting a method for multimodal active input elicitation according to one embodiment. The method begins 100. Inputs may be received concurrently from one or more or any combination of the input modalities, in any sequence. Thus, the method includes actively eliciting typed input 2610, speech input 2620, GUI-based input 2640, input in the context of a dialog 2650, and/or input resulting from event triggers 2660. Any or all of these input sources are unified into unified input format 2690 and returned. Unified input format 2690 enables the other components of intelligent automated assistant 1002 to be designed and to operate independently of the particular modality of the input.

**[0200]** Offering active guidance for multiple modalities and levels enables constraint and guidance on the input beyond those available to isolated modalities. For example, the kinds of suggestions offered to choose among speech, text, and dialog steps are independent, so their combination is a significant improvement over adding active elicitation techniques to individual modalities or levels.

**[0201]** Combining multiple sources of constraints as described herein (syntactic/linguistic, vocabulary, entity databases, domain models, task models, service models, and the like) and multiple places where these constraints may be actively applied (speech, text, GUI, dialog, and asynchronous events) provides a new level of functionality for human-machine interaction.

***Domain Models Component(s) 1056***

**[0202]** Domain models 1056 component(s) include representations of the concepts, entities, relations, properties, and instances of a domain. For example, dining out domain model 1622 might include the concept of a restaurant as a business with a name and an address and phone number, the concept of a meal event with a party size and date and time associated with the restaurant.

**[0203]** In at least one embodiment, domain models component(s) 1056 of assistant 1002 may be operable to perform and/or implement various types of functions, operations, actions, and/or other features such as, for example, one or more of the following (or combinations thereof):

- Domain model component(s) 1056 may be used by automated assistant 1002 for several processes, including: eliciting input 100, interpreting natural language 200, dispatching to services 400, and generating output 600.
- Domain model component(s) 1056 may provide lists of words that might match a domain concept or entity, such as names of restaurants, which may be used for active elicitation of input 100 and natural language processing 200.
- Domain model component(s) 1056 may classify candidate words in processes, for instance, to determine that a word is the name of a restaurant.
- Domain model component(s) 1056 may show the relationship between partial information for interpreting natural language, for example that cuisine may be associated with business entities (e.g.,

“local Mexican food” may be interpreted as “find restaurants with style = Mexican”, and this inference is possible because of the information in domain model 1056).

- Domain model component(s) 1056 may organize information about services used in service orchestration 1082, for example, that a particular web service may provide reviews of restaurants.
- Domain model component(s) 1056 may provide the information for generating natural language paraphrases and other output formatting, for example, by providing canonical ways of describing concepts, relations, properties and instances.

**[0204]** According to specific embodiments, multiple instances or threads of the domain models component(s) 1056 may be concurrently implemented and/or initiated via the use of one or more processors 63 and/or other combinations of hardware and/or hardware and software. For example, in at least some embodiments, various aspects, features, and/or functionalities of domain models component(s) 1056 may be performed, implemented and/or initiated by one or more of the following types of systems, components, systems, devices, procedures, processes, and the like (or combinations thereof):

- Domain models component(s) 1056 may be implemented as data structures that represent concepts, relations, properties, and instances. These data structures may be stored in memory, files, or databases.
- Access to domain model component(s) 1056 may be implemented through direct APIs, network APIs, database query interfaces, and/or the like.
- Creation and maintenance of domain models component(s) 1056 may be achieved, for example, via direct editing of files, database transactions, and/or through the use of domain model editing tools.

- Domain models component(s) 1056 may be implemented as part of or in association with active ontologies 1050, which combine models with instantiations of the models for servers and users.

**[0205]** According to various embodiments, one or more different threads or instances of domain models component(s) 1056 may be initiated in response to detection of one or more conditions or events satisfying one or more different types of minimum threshold criteria for triggering initiation of at least one instance of domain models component(s) 1056. For example, trigger initiation and/or implementation of one or more different threads or instances of domain models component(s) 1056 may be triggered when domain model information is required, including during input elicitation, input interpretation, task and domain identification, natural language processing, service orchestration, and/or formatting output for users.

**[0206]** In at least one embodiment, a given instance of domain models component(s) 1056 may access and/or utilize information from one or more associated databases. In at least one embodiment, at least a portion of the database information may be accessed via communication with one or more local and/or remote memory devices. For example, data from domain model component(s) 1056 may be associated with other model modeling components including vocabulary 1058, language pattern recognizers 1060, dialog flow models 1087, task flow models 1086, service capability models 1088, domain entity databases 1072, and the like. For example, businesses in domain entity databases 1072 that are classified as restaurants might be known by type identifiers which are maintained in the dining out domain model components.

*Domain Models Component(s) Example:*

**[0207]** Referring now to Fig. 27, there is shown a set of screen shots illustrating an example of various types of functions, operations, actions, and/or other features which may be provided by domain models component(s) 1056 according to one embodiment.

**[0208]** In at least one embodiment, domain models component(s) 1056 are the unifying data representation that enables the presentation of information shown in screens 103A and 103B about a restaurant, which combines data from several distinct data sources and services and which includes, for example: name, address, business categories, phone number, identifier for saving to long term personal memory, identifier for sharing over email, reviews from multiple sources, map coordinates, personal notes, and the like.

***Language Interpreter Component(s) 1070***

**[0209]** In at least one embodiment, language interpreter component(s) 1070 of assistant 1002 may be operable to perform and/or implement various types of functions, operations, actions, and/or other features such as, for example, one or more of the following (or combinations thereof):

- Analyze user input and identify a set of parse results.
  - *User input* can include any information from the user and his/her device context that can contribute to understanding the user's intent, which can include, for example one or more of the following (or combinations thereof): sequences of words, the identity of gestures or GUI elements involved in eliciting the input, current context of the dialog, current device application and its current data objects, and/or any other personal dynamic data obtained about the user such as location, time, and the like. For example, in one embodiment, user input is in the form of the uniform annotated input format 2690 resulting from active input elicitation 1094.
  - *Parse results* are associations of data in the user input with concepts, relationships, properties, instances, and/or other nodes and/or data structures in models, databases, and/or other representations of user intent and/context. Parse result associations can be complex mappings from sets and se-

quences of words, signals, and other elements of user input to one or more associated concepts, relations, properties, instances, other nodes, and/or data structures described herein.

- Analyze user input and identify a set of *syntactic* parse results, which are parse results that associate data in the user input with structures that represent syntactic parts of speech, clauses and phrases including multiword names, sentence structure, and/or other grammatical graph structures. Syntactic parse results are described in element 212 of natural language processing procedure described in connection with Fig. 28.
- Analyze user input and identify a set of *semantic* parse results, which are parse results that associate data in the user input with structures that represent concepts, relationships, properties, entities, quantities, propositions, and/or other representations of meaning and user intent. In one embodiment, these representations of meaning and intent are represented by sets of and/or elements of and/or instances of models or databases and/or nodes in ontologies, as described in element 220 of natural language processing procedure described in connection with Fig. 28.
- Disambiguate among alternative syntactic or semantic parse results as described in element 230 of natural language processing procedure described in connection with Fig. 28.
- Determine whether a partially typed input is syntactically and/or semantically meaningful in an autocomplete procedure such as one described in connection with Fig. 11.
- Help generate suggested completions 114 in an autocomplete procedure such as one described in connection with Fig. 11.



- Determine whether interpretations of spoken input are syntactically and/or semantically meaningful in a speech input procedure such as one described in connection with Fig. 22.

**[0210]** According to specific embodiments, multiple instances or threads of language interpreter component(s) 1070 may be concurrently implemented and/or initiated via the use of one or more processors 63 and/or other combinations of hardware and/or hardware and software.

**[0211]** According to different embodiments, one or more different threads or instances of language interpreter component(s) 1070 may be initiated in response to detection of one or more conditions or events satisfying one or more different types of minimum threshold criteria for triggering initiation of at least one instance of language interpreter component(s) 1070. Various examples of conditions or events which may trigger initiation and/or implementation of one or more different threads or instances of language interpreter component(s) 1070 may include, but are not limited to, one or more of the following (or combinations thereof):

- while eliciting input, including but not limited to
  - Suggesting possible completions of typed input 114 (Fig. 11);
  - Ranking interpretations of speech 126 (Fig. 22);
  - When offering ambiguities as suggested responses in dialog 152 (Fig. 24);
- when the result of eliciting input is available, including when input is elicited by any mode of active multimodal input elicitation 100.

**[0212]** In at least one embodiment, a given instance of language interpreter component(s) 1070 may access and/or utilize information from one or more associated databases. In at least one embodiment, at least a portion of such database information may be accessed via communication with one or more local and/or remote memory devices. Examples of different types of data which may be accessed by the Language Interpreter component(s) may in-

clude, but are not limited to, one or more of the following (or combinations thereof):

- Domain models 1056;
- Vocabulary 1058;
- Domain entity databases 1072;
- Short term memory 1052;
- Long term personal memory 1054;
- Task flow models 1086;
- Dialog flow models 1087;
- Service capability models 1088.

**[0213]** Referring now also to Fig. 29, there is shown a screen shot illustrating natural language processing according to one embodiment. The user has entered (via voice or text) language input 2902 consisting of the phrase “who is playing this weekend at the filmore”. This phrase is echoed back to the user on screen 2901. Language interpreter component(s) 1070 component process input 2902 and generates a parse result. The parse result associates that input with a request to show the local events that are scheduled for any of the upcoming weekend days at any event venue whose name matches “filmore”. A paraphrase of the parse results is shown as 2903 on screen 2901.

**[0214]** Referring now also to Fig. 28, there is shown a flow diagram depicting an example of a method for natural language processing according to one embodiment.

**[0215]** The method begins 200. Language input 202 is received, such as the string “who is playing this weekend at the filmore” in the example of Fig. 29. In one embodiment, the input is augmented by current context information, such as the current user location and local time. In word/phrase matching 210, language interpreter component(s) 1070 find associations between user input and concepts. In this example, associations are found between the string “playing” and the concept of listings at event venues; the string “this weekend” (along with the current local time of the user) and an instantiation

of an approximate time period that represents the upcoming weekend; and the string “filmore” with the name of a venue. Word/phrase matching 210 may use data from, for example, language pattern recognizers 1060, vocabulary database 1058, active ontology 1050, short term personal memory 1052, and long term personal memory 1054.

**[0216]** Language interpreter component(s) 1070 generate candidate syntactic parses 212 which include the chosen parse result but may also include other parse results. For example, other parse results may include those wherein “playing” is associated with other domains such as games or with a category of event such as sporting events.

**[0217]** Short- and/or long-term memory 1052, 1054 can also be used by language interpreter component(s) 1070 in generating candidate syntactic parses 212. Thus, input that was provided previously in the same session, and/or known information about the user, can be used, to improve performance, reduce ambiguity, and reinforce the conversational nature of the interaction. Data from active ontology 1050, domain models 1056, and task flow models 1086 can also be used, to implement evidential reasoning in determining valid candidate syntactic parses 212.

**[0218]** In semantic matching 220, language interpreter component(s) 1070 consider combinations of possible parse results according to how well they fit semantic models such as domain models and databases. In this case, the parse includes the associations (1) “playing” (a word in the user input) as “*Local Event At Venue*” (part of a domain model 1056 represented by a cluster of nodes in active ontology 1050) and (2) “filmore” (another word in the input) as a match to an entity name in a domain entity database 1072 for Local Event Venues, which is represented by a domain model element and active ontology node (*Venue Name*).

**[0219]** Semantic matching 220 may use data from, for example, active ontology 1050, short term personal memory 1052, and long term personal memory 1054. For example, semantic matching 220 may use data from previous

references to venues or local events in the dialog (from short term personal memory 1052) or personal favorite venues (from long term personal memory 1054).

**[0220]** A set of candidate, or potential, semantic parse results is generated 222.

**[0221]** In disambiguation step 230, language interpreter component(s) 1070 weigh the evidential strength of candidate semantic parse results 222. In this example, the combination of the parse of “playing” as “*Local Event At Venue*” and the match of “filmore” as a *Venue Name* is a stronger match to a domain model than alternative combinations where, for instance, “playing” is associated with a domain model for sports but there is no association in the sports domain for “filmore”.

**[0222]** Disambiguation 230 may use data from, for example, the structure of active ontology 1050. In at least one embodiment, the connections between nodes in an active ontology provide evidential support for disambiguating among candidate semantic parse results 222. For example, in one embodiment, if three active ontology nodes are semantically matched and are all connected in active ontology 1050, this indicates higher evidential strength of the semantic parse than if these matching nodes were not connected or connected by longer paths of connections in active ontology 1050. For example, in one embodiment of semantic matching 220, the parse that matches both *Local Event At Venue* and *Venue Name* is given increased evidential support because the combined representations of these aspects of the user intent are connected by links and/or relations in active ontology 1050: in this instance, the *Local Event* node is connected to the *Venue* node which is connected to the *Venue Name* node which is connected to the entity name in the database of venue names.

**[0223]** In at least one embodiment, the connections between nodes in an active ontology that provide evidential support for disambiguating among candidate semantic parse results 222 are directed arcs, forming an inference

lattice, in which matching nodes provide evidence for nodes to which they are connected by directed arcs.

**[0224]** In 232, language interpreter component(s) 1070 sort and select 232 the top semantic parses as the representation of user intent 290.

***Domain Entity Database(s) 1072***

**[0225]** In at least one embodiment, domain entity database(s) 1072 may be operable to perform and/or implement various types of functions, operations, actions, and/or other features such as, for example, one or more of the following (or combinations thereof):

- Store data about domain entities. Domain entities are things in the world or computing environment that may be modeled in domain models. Examples may include, but are not limited to, one or more of the following (or combinations thereof):
  - Businesses of any kind;
  - Movies, videos, songs and/or other musical products, and/or any other named entertainment products;
  - Products of any kind;
  - Events;
  - Calendar entries;
  - Cities, states, countries, neighborhoods, and/or other geographic, geopolitical, and/or geospatial points or regions;
  - Named places such as landmarks, airports, and the like;
- Provide database services on these databases, including but not limited to simple and complex queries, transactions, triggered events, and the like.

**[0226]** According to specific embodiments, multiple instances or threads of domain entity database(s) 1072 may be concurrently implemented and/or initiated via the use of one or more processors 63 and/or other combinations of hardware and/or hardware and software. For example, in at least some em-

bodiments, various aspects, features, and/or functionalities of domain entity database(s) 1072 may be performed, implemented and/or initiated by database software and/or hardware residing on client(s) 1304 and/or on server(s) 1340.

**[0227]** One example of a domain entity database 1072 that can be used in connection with the present invention according to one embodiment is a database of one or more businesses storing, for example, their names and locations. The database might be used, for example, to look up words contained in an input request for matching businesses and/or to look up the location of a business whose name is known. One skilled in the art will recognize that many other arrangements and implementations are possible.

### ***Vocabulary Component(s) 1058***

**[0228]** In at least one embodiment, vocabulary component(s) 1058 may be operable to perform and/or implement various types of functions, operations, actions, and/or other features such as, for example, one or more of the following (or combinations thereof):

- Provide databases associating words and strings with concepts, properties, relations, or instances of domain models or task models;
- Vocabulary from vocabulary components may be used by automated assistant 1002 for several processes, including for example: eliciting input, interpreting natural language, and generating output.

**[0229]** According to specific embodiments, multiple instances or threads of vocabulary component(s) 1058 may be concurrently implemented and/or initiated via the use of one or more processors 63 and/or other combinations of hardware and/or hardware and software. For example, in at least some embodiments, various aspects, features, and/or functionalities of vocabulary component(s) 1058 may be implemented as data structures that associate strings with the names of concepts, relations, properties, and instances. These

data structures may be stored in memory, files, or databases. Access to vocabulary component(s) 1058 may be implemented through direct APIs, network APIs, and/or database query interfaces. Creation and maintenance of vocabulary component(s) 1058 may be achieved via direct editing of files, database transactions, or through the use of domain model editing tools. Vocabulary component(s) 1058 may be implemented as part of or in association with active ontologies 1050. One skilled in the art will recognize that many other arrangements and implementations are possible.

**[0230]** According to different embodiments, one or more different threads or instances of vocabulary component(s) 1058 may be initiated in response to detection of one or more conditions or events satisfying one or more different types of minimum threshold criteria for triggering initiation of at least one instance of vocabulary component(s) 1058. In one embodiment, vocabulary component(s) 1058 are accessed whenever vocabulary information is required, including, for example, during input elicitation, input interpretation, and formatting output for users. One skilled in the art will recognize that other conditions or events may trigger initiation and/or implementation of one or more different threads or instances of vocabulary component(s) 1058.

**[0231]** In at least one embodiment, a given instance of vocabulary component(s) 1058 may access and/or utilize information from one or more associated databases. In at least one embodiment, at least a portion of the database information may be accessed via communication with one or more local and/or remote memory devices. In one embodiment, vocabulary component(s) 1058 may access data from external databases, for instance, from a data warehouse or dictionary.

### ***Language Pattern Recognizer Component(s) 1060***

**[0232]** In at least one embodiment, language pattern recognizer component(s) 1060 may be operable to perform and/or implement various types of functions, operations, actions, and/or other features such as, for example,

looking for patterns in language or speech input that indicate grammatical, idiomatic, and/or other composites of input tokens. These patterns correspond to, for example, one or more of the following (or combinations thereof): words, names, phrases, data, parameters, commands, and/or signals of speech acts.

**[0233]** According to specific embodiments, multiple instances or threads of pattern recognizer component(s) 1060 may be concurrently implemented and/or initiated via the use of one or more processors 63 and/or other combinations of hardware and/or hardware and software. For example, in at least some embodiments, various aspects, features, and/or functionalities of language pattern recognizer component(s) 1060 may be performed, implemented and/or initiated by one or more files, databases, and/or programs containing expressions in a pattern matching language. In at least one embodiment, language pattern recognizer component(s) 1060 are represented declaratively, rather than as program code; this enables them to be created and maintained by editors and other tools other than programming tools. Examples of declarative representations may include, but are not limited to, one or more of the following (or combinations thereof): regular expressions, pattern matching rules, natural language grammars, parsers based on state machines and/or other parsing models.

**[0234]** One skilled in the art will recognize that other types of systems, components, systems, devices, procedures, processes, and the like (or combinations thereof) can be used for implementing language pattern recognizer component(s) 1060.

**[0235]** According to different embodiments, one or more different threads or instances of language pattern recognizer component(s) 1060 may be initiated in response to detection of one or more conditions or events satisfying one or more different types of minimum threshold criteria for triggering initiation of at least one instance of language pattern recognizer component(s) 1060. Various examples of conditions or events which may trigger initiation



and/or implementation of one or more different threads or instances of language pattern recognizer component(s) 1060 may include, but are not limited to, one or more of the following (or combinations thereof):

- during active elicitation of input, in which the structure of the language pattern recognizers may constrain and guide the input from the user;
- during natural language processing, in which the language pattern recognizers help interpret input as language;
- during the identification of tasks and dialogs, in which the language pattern recognizers may help identify tasks, dialogs, and/or steps therein.

**[0236]** In at least one embodiment, a given instance of language pattern recognizer component(s) 1060 may access and/or utilize information from one or more associated databases. In at least one embodiment, at least a portion of the database information may be accessed via communication with one or more local and/or remote memory devices. Examples of different types of data which may be accessed by language pattern recognizer component(s) 1060 may include, but are not limited to, data from any of the models various models and data sources that may be part of embodiments of assistant 1002, which may include, but are not limited to, one or more of the following (or combinations thereof):

- Domain models 1056;
- Vocabulary 1058;
- Domain entity databases 1072;
- Short term memory 1052;
- Long term personal memory 1054;
- Task flow models 1086;
- Dialog flow models 1087;
- Service capability models 1088.

**[0237]** In one embodiment, access of data from other parts of embodiments of assistant 1002 may be coordinated by active ontologies 1050.

**[0238]** Referring again to Fig. 14, there is shown an example of some of the various types of functions, operations, actions, and/or other features which may be provided by language pattern recognizer component(s) 1060. Fig. 14 illustrates language patterns that language pattern recognizer component(s) 1060 may recognize. For example, the idiom “what is happening” (in a city) may be associated with the task of event planning and the domain of local events.

***Dialog Flow Processor Component(s) 1080***

**[0239]** In at least one embodiment, dialog flow processor component(s) 1080 may be operable to perform and/or implement various types of functions, operations, actions, and/or other features such as, for example, one or more of the following (or combinations thereof):

- Given a representation of the user intent 290 from language interpretation 200, identify the task a user wants performed and/or a problem the user wants solved. For example, a task might be to find a restaurant.
- For a given problem or task, given a representation of user intent 290, identify parameters to the task or problem. For example, the user might be looking for a recommended restaurant that serves Italian food near the user’s home. The constraints that a restaurant be recommended, serving Italian food, and near home are parameters to the task of finding a restaurant.
- Given the task interpretation and current dialog with the user, such as that which may be represented in personal short term memory 1052, select an appropriate dialog flow model and determine a step in the flow model corresponding to the current state.

**[0240]** According to specific embodiments, multiple instances or threads of dialog flow processor component(s) 1080 may be concurrently implemented and/or initiated via the use of one or more processors 63 and/or other combinations of hardware and/or hardware and software.

**[0241]** In at least one embodiment, a given instance of dialog flow processor component(s) 1080 may access and/or utilize information from one or more associated databases. In at least one embodiment, at least a portion of the database information may be accessed via communication with one or more local and/or remote memory devices. Examples of different types of data which may be accessed by dialog flow processor component(s) 1080 may include, but are not limited to, one or more of the following (or combinations thereof):

- task flow models 1086;
- domain models 1056;
- dialog flow models 1087.

**[0242]** Referring now to Figs. 30 and 31, there are shown screen shots illustrating an example of various types of functions, operations, actions, and/or other features which may be provided by dialog flow processor component(s) according to one embodiment.

**[0243]** As shown in screen 3001, user requests a dinner reservation by providing speech or text input “book me a table for dinner”. Assistant 1002 generates a prompt 3003 asking the user to specify time and party size.

**[0244]** Once these parameters have been provided, screen 3101 is shown. Assistant 1002 outputs a dialog box 3102 indicating that results are being presented, and a prompt 3103 asking the user to click a time. Listings 3104 are also displayed.

**[0245]** In one embodiment, such a dialog is implemented as follows. Dialog flow processor component(s) 1080 are given a representation of user intent from language interpreter component 1070 and determine that the appropriate response is to ask the user for information required to perform the next

step in a task flow. In this case, the domain is restaurants, the task is getting a reservation, and the dialog step is to ask the user for information required to accomplish the next step in the task flow. This dialog step is exemplified by prompt 3003 of screen 3001.

**[0246]** Referring now also to Fig. 32, there is shown a flow diagram depicting a method of operation for dialog flow processor component(s) 1080 according to one embodiment. The flow diagram of Fig. 32 is described in connection with the example shown in Figs. 30 and 31.

**[0247]** The method begins 200. Representation of user intent 290 is received. As described in connection with Fig. 28, in one embodiment, representation of user intent 290 is a set of semantic parses. For the example shown in Figs. 30 and 31, the domain is restaurants, the verb is “book” associated with restaurant reservations, and the time parameter is the evening of the current day.

**[0248]** In 310, dialog flow processor component(s) 1080 determine whether this interpretation of user intent is supported strongly enough to proceed, and/or if it is better supported than alternative ambiguous parses. In the current example, the interpretation is strongly supported, with no competing ambiguous parses. If, on the other hand, there are competing ambiguities or sufficient uncertainty, then step 322 is performed, to set the dialog flow step so that the execution phase causes the dialog to output a prompt for more information from the user.

**[0249]** In 312, the dialog flow processor component(s) 1080 determine the preferred interpretation of the semantic parse with other information to determine the task to perform and its parameters. Information may be obtained, for example, from domain models 1056, task flow models 1086, and/or dialog flow models 1087, or any combination thereof. In the current example, the task is identified as getting a reservation, which involves both finding a place that is reservable and available, and effecting a transaction to

reserve a table. Task parameters are the time constraint along with others that are inferred in step 312.

**[0250]** In 320, the task flow model is consulted to determine an appropriate next step. Information may be obtained, for example, from domain models 1056, task flow models 1086, and/or dialog flow models 1087, or any combination thereof. In the example, it is determined that in this task flow the next step is to elicit missing parameters to an availability search for restaurants, resulting in prompt 3003 illustrated in Fig. 30, requesting party size and time for a reservation.

**[0251]** As described above, Fig. 31 depicts screen 3101 is shown including dialog element 3102 that is presented after the user answers the request for the party size and reservation time. In one embodiment, screen 3101 is presented as the result of another iteration through an automated call and response procedure, as described in connection with Fig. 33, which leads to another call to the dialog and flow procedure depicted in Fig. 32. In this instantiation of the dialog and flow procedure, after receiving the user preferences, dialog flow processor component(s) 1080 determines a different task flow step in step 320: to do an availability search. When request 390 is constructed, it includes the task parameters sufficient for dialog flow processor component(s) 1080 and services orchestration component(s) 1082 to dispatch to a restaurant booking service.

### ***Dialog Flow Models Component(s) 1087***

**[0252]** In at least one embodiment, dialog flow models component(s) 1087 may be operable to provide dialog flow models, which represent the steps one takes in a particular kind of conversation between a user and intelligent automated assistant 1002. For example, the dialog flow for the generic task of performing a transaction includes steps for getting the necessary data for the transaction and confirming the transaction parameters before committing it.

***Task Flow Models Component(s) 1086***

**[0253]** In at least one embodiment, task flow models component(s) 1086 may be operable to provide task flow models, which represent the steps one takes to solve a problem or address a need. For example, the task flow for getting a dinner reservation involves finding a desirable restaurant, checking availability, and doing a transaction to get a reservation for a specific time with the restaurant.

**[0254]** According to specific embodiments, multiple instances or threads of task flow models component(s) 1086 may be concurrently implemented and/or initiated via the use of one or more processors 63 and/or other combinations of hardware and/or hardware and software. For example, in at least some embodiments, various aspects, features, and/or functionalities of task flow models component(s) 1086 may be implemented as programs, state machines, or other ways of identifying an appropriate step in a flow graph.

**[0255]** In at least one embodiment, task flow models component(s) 1086 may use a task modeling framework called generic tasks. Generic tasks are abstractions that model the steps in a task and their required inputs and generated outputs, without being specific to domains. For example, a generic task for transactions might include steps for gathering data required for the transaction, executing the transaction, and outputting results of the transaction -- all without reference to any particular transaction domain or service for implementing it. It might be instantiated for a domain such as shopping, but it is independent of the shopping domain and might equally well apply to domains of reserving, scheduling, and the like.

**[0256]** At least a portion of the functions, operations, actions, and/or other features associated with task flow models component(s) 1086 and/or procedure(s) described herein may be implemented, at least in part, using concepts, features, components, processes, and/or other aspects disclosed herein in connection with generic task modeling framework.

**[0257]** Additionally, at least a portion of the functions, operations, actions, and/or other features associated with task flow models component(s) 1086 and/or procedure(s) described herein may be implemented, at least in part, using concepts, features, components, processes, and/or other aspects relating to constrained selection tasks, as described herein. For example, one embodiment of generic tasks may be implemented using a constrained selection task model.

**[0258]** In at least one embodiment, a given instance of task flow models component(s) 1086 may access and/or utilize information from one or more associated databases. In at least one embodiment, at least a portion of the database information may be accessed via communication with one or more local and/or remote memory devices. Examples of different types of data which may be accessed by task flow models component(s) 1086 may include, but are not limited to, one or more of the following (or combinations thereof):

- Domain models 1056;
- Vocabulary 1058;
- Domain entity databases 1072;
- Short term memory 1052;
- Long term personal memory 1054;
- Dialog flow models 1087;
- Service capability models 1088.

**[0259]** Referring now to Fig. 34, there is shown a flow diagram depicting an example of task flow for a constrained selection task 351 according to one embodiment.

**[0260]** Constrained selection is a kind of generic task in which the goal is to select some item from a set of items in the world based on a set of constraints. For example, a constrained selection task 351 may be instantiated for the domain of restaurants. Constrained selection task 351 starts by soliciting criteria and constraints from the user 352. For example, the user might be interested in Asian food and may want a place to eat near his or her office.

**[0261]** In step 353, assistant 1002 presents items that meet the stated criteria and constraints for the user to browse. In this example, it may be a list of restaurants and their properties which may be used to select among them.

**[0262]** In step 354, the user is given an opportunity to refine criteria and constraints. For example, the user might refine the request by saying “near my office”. The system would then present a new set of results in step 353.

**[0263]** Referring now also to Fig. 35, there is shown an example of screen 3501 including list 3502 of items presented by constrained selection task 351 according to one embodiment.

**[0264]** In step 355, the user can select among the matching items. Any of a number of follow-on tasks 359 may then be made available, such as for example book 356, remember 357, or share 358. In various embodiments, follow-on tasks 359 can involve interaction with web-enabled services, and/or with functionality local to the device (such as setting a calendar appointment, making a telephone call, sending an email or text message, setting an alarm, and the like).

**[0265]** In the example of Fig. 35, the user can select an item within list 3502 to see more details and to perform additional actions. Referring now also to Fig. 36, there is shown an example of screen 3601 after the user has selected an item from list 3502. Additional information and options corresponding to follow-on tasks 359 concerning the selected item are displayed.

**[0266]** In various embodiments, the flow steps may be offered to the user in any of several input modalities, including but not limited to any combination of explicit dialog prompts and GUI links.

### ***Services Component(s) 1084***

**[0267]** Services component(s) 1084 represent the set of services that intelligent automated assistant 1002 might call on behalf of the user. Any service that can be called may be offered in a services component 1084.



**[0268]** In at least one embodiment, services component(s) 1084 may be operable to perform and/or implement various types of functions, operations, actions, and/or other features such as, for example, one or more of the following (or combinations thereof):

- Provide the functions over an API that would normally be provided by a web-based user interface to a service. For example, a review website might provide a service API that would return reviews of a given entity automatically when called by a program. The API offers to intelligent automated assistant 1002 the services that a human would otherwise obtain by operating the user interface of the website.
- Provide the functions over an API that would normally be provided by a user interface to an application. For example, a calendar application might provide a service API that would return calendar entries automatically when called by a program. The API offers to intelligent automated assistant 1002 the services that a human would otherwise obtain by operating the user interface of the application. In one embodiment, assistant 1002 is able to initiate and control any of a number of different functions available on the device. For example, if assistant 1002 is installed on a smartphone, personal digital assistant, tablet computer, or other device, assistant 1002 can perform functions such as: initiate applications, make calls, send emails and/or text messages, add calendar events, set alarms, and the like. In one embodiment, such functions are activated using services component(s) 1084.
- Provide services that are not currently implemented in a user interface, but that are available through an API to assistant in larger tasks. For example, in one embodiment, an API to take a street address and return machine-readable geo-coordinates might be used

by assistant 1002 as a service component 1084 even if it has no direct user interface on the web or a device.

**[0269]** According to specific embodiments, multiple instances or threads of services component(s) 1084 may be concurrently implemented and/or initiated via the use of one or more processors 63 and/or other combinations of hardware and/or hardware and software. For example, in at least some embodiments, various aspects, features, and/or functionalities of services component(s) 1084 may be performed, implemented and/or initiated by one or more of the following types of systems, components, systems, devices, procedures, processes, and the like (or combinations thereof):

- implementation of an API exposed by a service, locally or remotely or any combination;
- inclusion of a database within automated assistant 1002 or a database service available to assistant 1002.

**[0270]** For example, a website that offers users an interface for browsing movies might be used by an embodiment of intelligent automated assistant 1002 as a copy of the database used by the website. Services component(s) 1084 would then offer an internal API to the data, as if it were provided over a network API, even though the data is kept locally.

**[0271]** As another example, services component(s) 1084 for an intelligent automated assistant 1002 that helps with restaurant selection and meal planning might include any or all of the following set of services which are available from third parties over the network:

- a set of restaurant listing services which lists restaurants matching name, location, or other constraints;
- a set of restaurant rating services which return rankings for named restaurants;
- a set of restaurant reviews services which returns written reviews for named restaurants;
- a geocoding service to locate restaurants on a map;

- a reservation service that enables programmatic reservation of tables at restaurants.

***Services Orchestration Component(s) 1082***

**[0272]** Services orchestration component(s) 1082 of intelligent automated assistant 1002 executes a service orchestration procedure.

**[0273]** In at least one embodiment, services orchestration component(s) 1082 may be operable to perform and/or implement various types of functions, operations, actions, and/or other features such as, for example, one or more of the following (or combinations thereof):

- Dynamically and automatically determine which services may meet the user's request and/or specified domain(s) and task(s);
- Dynamically and automatically call multiple services, in any combination of concurrent and sequential ordering;
- Dynamically and automatically transform task parameters and constraints to meet input requirements of service APIs;
- Dynamically and automatically monitor for and gather results from multiple services;
- Dynamically and automatically merge service results data from various services into to a unified result model;
- Orchestrate a plurality of services to meet the constraints of a request;
- Orchestrate a plurality of services to annotate an existing result set with auxiliary information;
- Output the result of calling a plurality of services in a uniform, service independent representation that unifies the results from the various services (for example, as a result of calling several restaurant services that return lists of restaurants, merge the data on at least one restaurant from the several services, removing redundancy).

**[0274]** For example, in some situations, there may be several ways to accomplish a particular task. For example, user input such as “remind me to leave for my meeting across town at 2pm” specifies an action that can be accomplished in at least three ways: set alarm clock; create a calendar event; or call a to-do manager. In one embodiment, services orchestration component(s) 1082 makes the determination as to which way to best satisfy the request.

**[0275]** Services orchestration component(s) 1082 can also make determinations as to which combination of several services would be best to invoke in order to perform a given overall task. For example, to find and reserve a table for dinner, services orchestration component(s) 1082 would make determinations as to which services to call in order to perform such functions as looking up reviews, getting availability, and making a reservation. Determination of which services to use may depend on any of a number of different factors. For example, in at least one embodiment, information about reliability, ability of service to handle certain types of requests, user feedback, and the like, can be used as factors in determining which service(s) is/are appropriate to invoke.

**[0276]** According to specific embodiments, multiple instances or threads of services orchestration component(s) 1082 may be concurrently implemented and/or initiated via the use of one or more processors and/or other combinations of hardware and/or hardware and software.

**[0277]** In at least one embodiment, a given instance of services orchestration component(s) 1082 may use explicit service capability models 1088 to represent the capabilities and other properties of external services, and reason about these capabilities and properties while achieving the features of services orchestration component(s) 1082. This affords advantages over manually programming a set of services that may include, for example, one or more of the following (or combinations thereof):

- Ease of development;

- Robustness and reliability in execution;
- The ability to dynamically add and remove services without disrupting code;
- The ability to implement general distributed query optimization algorithms that are driven by the properties and capabilities rather than hard coded to specific services or APIs.

**[0278]** In at least one embodiment, a given instance of services orchestration component(s) 1082 may access and/or utilize information from one or more associated databases. In at least one embodiment, at least a portion of the database information may be accessed via communication with one or more local and/or remote memory devices. Examples of different types of data which may be accessed by services orchestration component(s) 1082 may include, but are not limited to, one or more of the following (or combinations thereof):

- Instantiations of domain models;
- Syntactic and semantic parses of natural language input;
- Instantiations of task models (with values for parameters);
- Dialog and task flow models and/or selected steps within them;
- Service capability models 1088;
- Any other information available in an active ontology 1050.

**[0279]** Referring now to Fig. 37, there is shown an example of a procedure for executing a service orchestration procedure according to one embodiment.

**[0280]** In this particular example, it is assumed a single user is interesting in finding a good place for dinner at a restaurant, and is engaging intelligent automated assistant 1002 in a conversation to help provide this service.

**[0281]** Consider the task of finding restaurants that are of high quality, are well reviewed, near a particular location, available for reservation at a particular time, and serve a particular kind of food. These domain and task parameters are given as input 390.

**[0282]** The method begins 400. At 402, it is determined whether the given request may require any services. In some situations, services delegation may not be required, for example if assistant 1002 is able to perform the desired task itself. For example, in one embodiment, assistant 1002 may be able to answer a factual question without invoking services delegation. Accordingly, if the request does not require services, then standalone flow step is executed in 403 and its result 490 is returned. For example, if the task request was to ask for information about automated assistant 1002 itself, then the dialog response may be handled without invoking any external services.

**[0283]** If, in step 402, it is determined that services delegation is required, services orchestration component(s) 1082 proceed to step 404. In 404, services orchestration component(s) 1082 may match up the task requirements with declarative descriptions of the capabilities and properties of services in service capability models 1088. At least one service provider that might support the instantiated operation provides declarative, qualitative metadata detailing, for example, one or more of the following (or combinations thereof):

- the data fields that are returned with results;
- which classes of parameters the service provider is statically known to support;
- policy functions for parameters the service provider might be able to support after dynamic inspection of the parameter values;
- a performance rating defining how the service performs (e.g. relational DB, web service, triple store, full-text index, or some combination thereof);
- property quality ratings statically defining the expected quality of property values returned with the result object;
- an overall quality rating of the results the service may expect to return.

**[0284]** For example, reasoning about the classes of parameters that service may support, a service model may state that services 1, 2, 3, and 4 may pro-

vide restaurants that are near a particular location (a parameter), services 2 and 3 may filter or rank restaurants by quality (another parameter), services 3, 4, and 5 may return reviews for restaurants (a data field returned), service 6 may list the food types served by restaurants (a data field returned), and service 7 may check availability of restaurants for particular time ranges (a parameter). Services 8 through 99 offer capabilities that are not required for this particular domain and task.

**[0285]** Using this declarative, qualitative metadata, the task, the task parameters, and other information available from the runtime environment of the assistant, services orchestration component(s) 1082 determines 404 an optimal set of service providers to invoke. The optimal set of service providers may support one or more task parameters (returning results that satisfy one or more parameters) and also considers the performance rating of at least one service provider and the overall quality rating of at least one service provider.

**[0286]** The result of step 404 is a dynamically generated list of services to call for this particular user and request.

**[0287]** In at least one embodiment, services orchestration component(s) 1082 considers the reliability of services as well as their ability to answer specific information requests.

**[0288]** In at least one embodiment, services orchestration component(s) 1082 hedges against unreliability by calling overlapping or redundant services.

**[0289]** In at least one embodiment, services orchestration component(s) 1082 considers personal information about the user (from the short term personal memory component) to select services. For example, the user may prefer some rating services over others.

**[0290]** In step 450, services orchestration component(s) 1082 dynamically and automatically invokes multiple services on behalf of a user. In at least one embodiment, these are called dynamically while responding to a user's request. According to specific embodiments, multiple instances or threads of

the services may be concurrently called. In at least one embodiment, these are called over a network using APIs, or over a network using web service APIs, or over the Internet using web service APIs, or any combination thereof.

**[0291]** In at least one embodiment, the rate at which services are called is programmatically limited and/or managed.

**[0292]** Referring now also to Fig. 38, there is shown an example of a service invocation procedure 450 according to one embodiment. Service invocation is used, for example, to obtain additional information or to perform tasks by the use of external services. In one embodiment, request parameters are transformed as appropriate for the service's API. Once results are received from the service, the results are transformed to a results representation for presentation to the user within assistant 1002.

**[0293]** In at least one embodiment, services invoked by service invocation procedure 450 can be a web service, application running on the device, operating system function, or the like.

**[0294]** Representation of request 390 is provided, including for example task parameters and the like. For at least one service available from service capability models 1088, service invocation procedure 450 performs transformation 452, calling 454, and output-mapping 456 steps.

**[0295]** In transformation step 452, the current task parameters from request representation 390 are transformed into a form that may be used by at least one service. Parameters to services, which may be offered as APIs or databases, may differ from the data representation used in task requests, and also from at least one other. Accordingly, the objective of step 452 is to map at least one task parameter in the one or more corresponding formats and values in at least one service being called.

**[0296]** For example, the names of businesses such as restaurants may vary across services that deal with such businesses. Accordingly, step 452 would involve transforming any names into forms that are best suited for at least one service.



**[0297]** As another example, locations are known at various levels of precision and using various units and conventions across services. Service 1 might require ZIP codes, service 2 GPS coordinates, and service 3 postal street addresses.

**[0298]** The service is called 454 over an API and its data gathered. In at least one embodiment, the results are cached. In at least one embodiment, the services that do not return within a specified level performance (e.g., as specified in Service Level Agreement or SLA) are dropped.

**[0299]** In output mapping step 456, the data returned by a service is mapped back onto unified result representation 490. This step may include dealing with different formats, units, and so forth.

**[0300]** In step 412, results from multiple services are validated and merged. In one embodiment, if validated results are collected, an equality policy function--defined on a per-domain basis--is then called pair-wise across one or more results to determine which results represent identical concepts in the real world. When a pair of equal results is discovered, a set of property policy functions--also defined on a per-domain basis--are used to merge property values into a merged result. The property policy function may use the property quality ratings from the service capability models, the task parameters, the domain context, and/or the long-term personal memory 1054 to decide the optimal merging strategy.

**[0301]** For example, lists of restaurants from different providers of restaurants might be merged and duplicates removed. In at least one embodiment, the criteria for identifying duplicates may include fuzzy name matching, fuzzy location matching, fuzzy matching against multiple properties of domain entities, such as name, location, phone number, and/or website address, and/or any combination thereof.

**[0302]** In step 414, the results are sorted and trimmed to return a result list of the desired length.

**[0303]** In at least one embodiment, a request relaxation loop is also applied. If, in step 416, services orchestration component(s) 1082 determines that the current result list is not sufficient (e.g., it has fewer than the desired number of matching items), then task parameters may be relaxed 420 to allow for more results. For example, if the number of restaurants of the desired sort found within N miles of the target location is too small, then relaxation would run the request again, looking in an area larger than N miles away, and/or relaxing some other parameter of the search.

**[0304]** In at least one embodiment, the service orchestration method is applied in a second pass to “annotate” results with auxiliary data that is useful to the task.

**[0305]** In step 418, services orchestration component(s) 1082 determines whether annotation is required. It may be required if, for example, if the task may require a plot of the results on a map, but the primary services did not return geo-coordinates required for mapping.

**[0306]** In 422, service capability models 1088 are consulted again to find services that may return the desired extra information. In one embodiment, the annotation process determines if additional or better data may be annotated to a merged result. It does this by delegating to a property policy function--defined on a per-domain basis--for at least one property of at least one merged result. The property policy function may use the merged property value and property quality rating, the property quality ratings of one or more other service providers, the domain context, and/or the user profile to decide if better data may be obtained. If it is determined that one or more service providers may annotate one or more properties for a merged result, a cost function is invoked to determine the optimal set of service providers to annotate.

**[0307]** At least one service provider in the optimal set of annotation service providers is then invoked 450 with the list of merged results, to obtain results 424. The changes made to at least one merged result by at least one service

provider are tracked during this process, and the changes are then merged using the same property policy function process as was used in step 412. Their results are merged 426 into the existing result set.

**[0308]** The resulting data is sorted 428 and unified into a uniform representation 490.

**[0309]** It may be appreciated that one advantage of the methods and systems described above with respect to services orchestration component(s) 1082 is that they may be advantageously applied and/or utilized in various fields of technology other than those specifically relating to intelligent automated assistants. Examples of such other areas of technologies where aspects and/or features of service orchestration procedures include, for example, one or more of the following:

- Dynamic “mash ups” on websites and web-based applications and services;
- Distributed database query optimization;
- Dynamic service oriented architecture configuration.

***Service Capability Models Component(s) 1088***

**[0310]** In at least one embodiment, service capability models component(s) 1088 may be operable to perform and/or implement various types of functions, operations, actions, and/or other features such as, for example, one or more of the following (or combinations thereof):

- Provide machine readable information about the capabilities of services to perform certain classes of computation;
- Provide machine readable information about the capabilities of services to answer certain classes of queries;
- Provide machine readable information about which classes of transactions are provided by various services;
- Provide machine readable information about the parameters to APIs exposed by various services;

- Provide machine readable information about the parameters that may be used in database queries on databases provided by various services.

### ***Output Processor Component(s) 1090***

**[0311]** In at least one embodiment, output processor component(s) 1090 may be operable to perform and/or implement various types of functions, operations, actions, and/or other features such as, for example, one or more of the following (or combinations thereof):

- Format output data that is represented in a uniform internal data structure into forms and layouts that render it appropriately on different modalities. Output data may include, for example, communication in natural language between the intelligent automated assistant and the user; data about domain entities, such as properties of restaurants, movies, products, and the like; domain specific data results from information services, such as weather reports, flight status checks, prices, and the like; and/or interactive links and buttons that enable the user to respond by directly interacting with the output presentation.
- Render output data for modalities that may include, for example, any combination of: graphical user interfaces; text messages; email messages; sounds; animations; and/or speech output.
- Dynamically render data for different graphical user interface display engines based on the request. For example, use different output processing layouts and formats depending on which web browser and/or device is being used.
- Render output data in different speech voices dynamically.
- Dynamically render to specified modalities based on user preferences.

- Dynamically render output using user-specific “skins” that customize the look and feel.
- Send a stream of output packages to a modality, showing intermediate status, feedback, or results throughout phases of interaction with assistant 1002.

**[0312]** According to specific embodiments, multiple instances or threads of output processor component(s) 1090 may be concurrently implemented and/or initiated via the use of one or more processor(s) 63 and/or other combinations of hardware and/or hardware and software. For example, in at least some embodiments, various aspects, features, and/or functionalities of output processor component(s) 1090 may be performed, implemented and/or initiated by one or more of the following types of systems, components, systems, devices, procedures, processes, and the like (or combinations thereof):

- software modules within the client or server of an embodiment of an intelligent automated assistant;
- remotely callable services;
- using a mix of templates and procedural code.

**[0313]** Referring now to Fig. 39, there is shown a flow diagram depicting an example of a multiphase output procedure according to one embodiment. The multiphase output procedure includes automated assistant 1002 processing steps 702 and multiphase output steps 704

**[0314]** In step 710, a speech input utterance is obtained and a speech-to-text component (such as component described in connection with Fig. 22) interprets the speech to produce a set of candidate speech interpretations 712. In one embodiment, speech-to-text component is implemented using, for example, Nuance Recognizer, available from Nuance Communications, Inc. of Burlington, MA. Candidate speech interpretations 712 may be shown to the user in 730, for example in paraphrased form. For example, the interface might show “did you say?” alternatives listing a few possible alternative textual interpretations of the same speech sound sample.

**[0315]** In at least one embodiment, a user interface is provided to enable the user to interrupt and choose among the candidate speech interpretations.

**[0316]** In step 714, the candidate speech interpretations 712 are sent to a language interpreter 1070, which may produce representations of user intent 716 for at least one candidate speech interpretation 712. In step 732, paraphrases of these representations of user intent 716 are generated and presented to the user. (See related step 132 of procedure 120 in Fig. 22).

**[0317]** In at least one embodiment, the user interface enables the user to interrupt and choose among the paraphrases of natural language interpretations 732.

**[0318]** In step 718, task and dialog analysis is performed. In step 734, task and domain interpretations are presented to the user using an intent paraphrasing algorithm.

**[0319]** Referring now also to Fig. 40, there is shown a screen shot depicting an example of output processing according to one embodiment. Screen 4001 includes echo 4002 of the user's speech input, generated by step 730. Screen 4001 further includes paraphrase 4003 of the user's intent, generated by step 734. In one embodiment, as depicted in the example of Fig. 40, special formatting/highlighting is used for key words such as "events", which may be used to facilitate training of the user for interaction with intelligent automated assistant 1002. For example, by visually observing the formatting of the displayed text, the user may readily identify and interpret back the intelligent automated assistant recognizes keywords such as "events", "next Wednesday", "San Francisco", and the like.

**[0320]** Returning to Fig. 39, as requests are dispatched 720 to services and results are dynamically gathered, intermediate results may be displayed in the form of real-time progress 736. For example, a list of restaurants may be returned and then their reviews may be populated dynamically as the results from the reviews services arrive. Services can include web-enabled services

and/or services that access information stored locally on the device and/or from any other source.

**[0321]** A uniform representation of response 722 is generated and formatted 724 for the appropriate output modality. After the final output format is completed, a different kind of paraphrase may be offered in 738. In this phase, the entire result set may be analyzed and compared against the initial request. A summary of results or answer to a question may then be offered.

**[0322]** Referring also to Fig. 41, there is shown another example of output processing according to one embodiment. Screen 4101 depicts paraphrase 4102 of the text interpretation, generated by step 732, real-time progress 4103 generated by step 736, and paraphrased summary 7104 generated by step 738. Also included are detailed results 4105.

**[0323]** In one embodiment, assistant 1002 is capable of generating output in multiple modes. Referring now to Fig. 42, there is shown a flow diagram depicting an example of multimodal output processing according to one embodiment.

**[0324]** The method begins 600. Output processor 1090 takes uniform representation of response 490 and formats 612 the response according to the device and modality that is appropriate and applicable. Step 612 may include information from device and modality models 610 and/or domain data models 614.

**[0325]** Once response 490 has been formatted 612, any of a number of different output mechanisms can be used, in any combination. Examples depicted in Fig. 42 include:

- Generating 620 text message output, which is sent 630 to a text message channel;
- Generating 622 email output, which is sent 632 as an email message;
- Generating 624 GUI output, which is sent 634 to a device or web browser for rendering;

- Generating 626 speech output, which is sent 636 to a speech generation module.

**[0326]** One skilled in the art will recognize that many other output mechanisms can be used.

**[0327]** In one embodiment, the content of output messages generated by multiphase output procedure 700 is tailored to the mode of multimodal output processing 600. For example, if the output modality is speech 626, the language of used to paraphrase user input 730, text interpretations 732, task and domain interpretations 734, progress 736, and/or result summaries 738 may be more or less verbose or use sentences that are easier to comprehend in audible form than in written form. In one embodiment, the language is tailored in the steps of the multiphase output procedure 700; in other embodiments, the multiphase output procedure 700 produces an intermediate result that is further refined into specific language by multimodal output processing 600.

### ***Short Term Personal Memory Component(s) 1052***

**[0328]** In at least one embodiment, short term personal memory component(s) 1052 may be operable to perform and/or implement various types of functions, operations, actions, and/or other features such as, for example, one or more of the following (or combinations thereof):

- Keep a history of the recent dialog between the embodiment of the assistant and the user, including the history of user inputs and their interpretations;
- Keep a history of recent selections by the user in the GUI, such as which items were opened or explored, which phone numbers were called, which items were mapped, which movie trailers where played, and the like;



- Store the history of the dialog and user interactions in a database on the client, the server in a user-specific session, or in client session state such as web browser cookies or RAM used by the client;
- Store the list of recent user requests;
- Store the sequence of results of recent user requests;
- Store the click-stream history of UI events, including button presses, taps, gestures, voice activated triggers, and/or any other user input.
- Store device sensor data (such as location, time, positional orientation, motion, light level, sound level, and the like) which might be correlated with interactions with the assistant.

**[0329]** According to specific embodiments, multiple instances or threads of short term personal memory component(s) 1052 may be concurrently implemented and/or initiated via the use of one or more processors 63 and/or other combinations of hardware and/or hardware and software.

**[0330]** According to different embodiments, one or more different threads or instances of short term personal memory component(s) 1052 may be initiated in response to detection of one or more conditions or events satisfying one or more different types of minimum threshold criteria for triggering initiation of at least one instance of short term personal memory component(s) 1052. For example, short term personal memory component(s) 1052 may be invoked when there is a user session with the embodiment of assistant 1002, on at least one input form or action by the user or response by the system.

**[0331]** In at least one embodiment, a given instance of short term personal memory component(s) 1052 may access and/or utilize information from one or more associated databases. In at least one embodiment, at least a portion of the database information may be accessed via communication with one or more local and/or remote memory devices. For example, short term personal memory component(s) 1052 may access data from long-term personal memory components(s) 1054 (for example, to obtain user identity and personal

preferences) and/or data from the local device about time and location, which may be included in short term memory entries.

**[0332]** Referring now to Figs. 43A and 43B, there are shown screen shots depicting an example of the use of short term personal memory component(s) 1052 to maintain dialog context while changing location, according to one embodiment. In this example, the user has asked about the local weather, then just says “in new york”. Screen 4301 shows the initial response, including local weather. When the user says “in new york”, assistant 1002 uses short term personal memory component(s) 1052 to access the dialog context and thereby determine that the current domain is weather forecasts. This enables assistant 1002 to interpret the new utterance “in new york” to mean “what is the weather forecast in New York this coming Tuesday?”. Screen 4302 shows the appropriate response, including weather forecasts for New York.

**[0333]** In the example of Figs. 43A and 43B, what was stored in short term memory was not only the words of the input “is it going to rain the day after tomorrow?” but the system’s semantic interpretation of the input as the weather domain and the time parameter set to the day after tomorrow.

### ***Long-Term Personal Memory Component(s) 1054***

**[0334]** In at least one embodiment, long-term personal memory component(s) 1054 may be operable to perform and/or implement various types of functions, operations, actions, and/or other features such as, for example, one or more of the following (or combinations thereof):

- To persistently store the personal information and data about a user, including for example his or her preferences, identities, authentication credentials, accounts, addresses, and the like;
- To store information that the user has collected by using the embodiment of assistant 1002, such as the equivalent of bookmarks, favorites, clippings, and the like;

- To persistently store saved lists of business entities including restaurants, hotels, stores, theaters and other venues. In one embodiment, long-term personal memory component(s) 1054 saves more than just the names or URLs, but also saves the information sufficient to bring up a full listing on the entities including phone numbers, locations on a map, photos, and the like;
- To persistently store saved movies, videos, music, shows, and other items of entertainment;
- To persistently store the user's personal calendar(s), to do list(s), reminders and alerts, contact databases, social network lists, and the like;
- To persistently store shopping lists and wish lists for products and services, coupons and discount codes acquired, and the like;
- To persistently store the history and receipts for transactions including reservations, purchases, tickets to events, and the like.

**[0335]** According to specific embodiments, multiple instances or threads of long-term personal memory component(s) 1054 may be concurrently implemented and/or initiated via the use of one or more processors 63 and/or other combinations of hardware and/or hardware and software. For example, in at least some embodiments, various aspects, features, and/or functionalities of long-term personal memory component(s) 1054 may be performed, implemented and/or initiated using one or more databases and/or files on (or associated with) clients 1304 and/or servers 1340, and/or residing on storage devices.

**[0336]** According to different embodiments, one or more different threads or instances of long-term personal memory component(s) 1054 may be initiated in response to detection of one or more conditions or events satisfying one or more different types of minimum threshold criteria for triggering initiation of at least one instance of long-term personal memory component(s) 1054. Various examples of conditions or events which may trigger initiation

and/or implementation of one or more different threads or instances of long-term personal memory component(s) 1054 may include, but are not limited to, one or more of the following (or combinations thereof):

- Long term personal memory entries may be acquired as a side effect of the user interacting with an embodiment of assistant 1002. Any kind of interaction with the assistant may produce additions to the long term personal memory, including browsing, searching, finding, shopping, scheduling, purchasing, reserving, communicating with other people via an assistant.
- Long term personal memory may also be accumulated as a consequence of users signing up for an account or service, enabling assistant 1002 access to accounts on other services, using an assistant 1002 service on a client device with access to other personal information databases such as calendars, to-do lists, contact lists, and the like.

**[0337]** In at least one embodiment, a given instance of long-term personal memory component(s) 1054 may access and/or utilize information from one or more associated databases. In at least one embodiment, at least a portion of the database information may be accessed via communication with one or more local and/or remote memory devices, which may be located, for example, at client(s) 1304 and/or server(s) 1340. Examples of different types of data which may be accessed by long-term personal memory component(s) 1054 may include, but are not limited to data from other personal information databases such as contact or friend lists, calendars, to-do lists, other list managers, personal account and wallet managers provided by external services 1360, and the like.

**[0338]** Referring now to Figs. 44A through 44C, there are shown screen shots depicting an example of the use of long term personal memory component(s) 1054, according to one embodiment. In the example, a feature is provided (named "My Stuff"), which includes access to saved entities such as res-

taurants, movies, and businesses that are found via interactive sessions with an embodiment of assistant 1002. In screen 4401 of Fig. 44A, the user has found a restaurant. The user taps on Save to My Stuff 4402, which saves information about the restaurant in long-term personal memory component(s) 1054.

**[0339]** Screen 4403 of Fig. 44B depicts user access to My Stuff. In one embodiment, the user can select among categories to navigate to the desired item.

**[0340]** Screen 4404 of Fig. 44C depicts the My Restaurant category, including items previously stored in My Stuff.

### ***Automated Call and Response Procedure***

**[0341]** Referring now to Fig. 33, there is shown a flow diagram depicting an automatic call and response procedure, according to one embodiment. The procedure of Fig. 33 may be implemented in connection with one or more embodiments of intelligent automated assistant 1002. It may be appreciated that intelligent automated assistant 1002 as depicted in Fig. 1 is merely one example from a wide range of intelligent automated assistant system embodiments which may be implemented. Other embodiments of intelligent automated assistant systems (not shown) may include additional, fewer and/or different components/features than those illustrated, for example, in the example intelligent automated assistant 1002 depicted in Fig. 1.

**[0342]** In at least one embodiment, the automated call and response procedure of Fig. 33 may be operable to perform and/or implement various types of functions, operations, actions, and/or other features such as, for example, one or more of the following (or combinations thereof):

- The automated call and response procedure of Fig. 33 may provide an interface control flow loop of a conversational interface between the user and intelligent automated assistant 1002. At least one iteration of the automated call and response procedure may serve as a

ply in the conversation. A conversational interface is an interface in which the user and assistant 1002 communicate by making utterances back and forth in a conversational manner.

- The automated call and response procedure of Fig. 33 may provide the executive control flow for intelligent automated assistant 1002. That is, the procedure controls the gathering of input, processing of input, generation of output, and presentation of output to the user.
- The automated call and response procedure of Fig. 33 may coordinate communications among components of intelligent automated assistant 1002. That is, it may direct where the output of one component feeds into another, and where the overall input from the environment and action on the environment may occur.

**[0343]** In at least some embodiments, portions of the automated call and response procedure may also be implemented at other devices and/or systems of a computer network.

**[0344]** According to specific embodiments, multiple instances or threads of the automated call and response procedure may be concurrently implemented and/or initiated via the use of one or more processors 63 and/or other combinations of hardware and/or hardware and software. In at least one embodiment, one or more or selected portions of the automated call and response procedure may be implemented at one or more client(s) 1304, at one or more server(s) 1340, and/or combinations thereof.

**[0345]** For example, in at least some embodiments, various aspects, features, and/or functionalities of the automated call and response procedure may be performed, implemented and/or initiated by software components, network services, databases, and/or the like, or any combination thereof.

**[0346]** According to different embodiments, one or more different threads or instances of the automated call and response procedure may be initiated in response to detection of one or more conditions or events satisfying one or more different types of criteria (such as, for example, minimum threshold cri-

teria) for triggering initiation of at least one instance of automated call and response procedure. Examples of various types of conditions or events which may trigger initiation and/or implementation of one or more different threads or instances of the automated call and response procedure may include, but are not limited to, one or more of the following (or combinations thereof):

- a user session with an instance of intelligent automated assistant 1002, such as, for example, but not limited to, one or more of:
  - a mobile device application starting up, for instance, a mobile device application that is implementing an embodiment of intelligent automated assistant 1002;
  - a computer application starting up, for instance, an application that is implementing an embodiment of intelligent automated assistant 1002;
  - a dedicated button on a mobile device pressed, such as a “speech input button”;
  - a button on a peripheral device attached to a computer or mobile device, such as a headset, telephone handset or base station, a GPS navigation system, consumer appliance, remote control, or any other device with a button that might be associated with invoking assistance;
  - a web session started from a web browser to a website implementing intelligent automated assistant 1002;
  - an interaction started from within an existing web browser session to a website implementing intelligent automated assistant 1002, in which, for example, intelligent automated assistant 1002 service is requested;
  - an email message sent to a modality server 1426 that is mediating communication with an embodiment of intelligent automated assistant 1002;

- a text message is sent to a modality server 1426 that is mediating communication with an embodiment of intelligent automated assistant 1002;
  - a phone call is made to a modality server 1434 that is mediating communication with an embodiment of intelligent automated assistant 1002;
  - an event such as an alert or notification is sent to an application that is providing an embodiment of intelligent automated assistant 1002.
- when a device that provides intelligent automated assistant 1002 is turned on and/or started.

**[0347]** According to different embodiments, one or more different threads or instances of the automated call and response procedure may be initiated and/or implemented manually, automatically, statically, dynamically, concurrently, and/or combinations thereof. Additionally, different instances and/or embodiments of the automated call and response procedure may be initiated at one or more different time intervals (e.g., during a specific time interval, at regular periodic intervals, at irregular periodic intervals, upon demand, and the like).

**[0348]** In at least one embodiment, a given instance of the automated call and response procedure may utilize and/or generate various different types of data and/or other types of information when performing specific tasks and/or operations. This may include, for example, input data/information and/or output data/information. For example, in at least one embodiment, at least one instance of the automated call and response procedure may access, process, and/or otherwise utilize information from one or more different types of sources, such as, for example, one or more databases. In at least one embodiment, at least a portion of the database information may be accessed via communication with one or more local and/or remote memory devices. Additionally, at least one instance of the automated call and response proce-



cedure may generate one or more different types of output data/information, which, for example, may be stored in local memory and/or remote memory devices.

**[0349]** In at least one embodiment, initial configuration of a given instance of the automated call and response procedure may be performed using one or more different types of initialization parameters. In at least one embodiment, at least a portion of the initialization parameters may be accessed via communication with one or more local and/or remote memory devices. In at least one embodiment, at least a portion of the initialization parameters provided to an instance of the automated call and response procedure may correspond to and/or may be derived from the input data/information.

**[0350]** In the particular example of Fig. 33, it is assumed that a single user is accessing an instance of intelligent automated assistant 1002 over a network from a client application with speech input capabilities. The user is interested in finding a good place for dinner at a restaurant, and is engaging intelligent automated assistant 1002 in a conversation to help provide this service.

**[0351]** In step 100, the user is prompted to enter a request. The user interface of the client offers several modes of input, as described in connection with Fig. 26. These may include, for example:

- an interface for typed input, which may invoke an active typed-input elicitation procedure as illustrated in Fig. 11;
- an interface for speech input, which may invoke an active speech input elicitation procedure as illustrated in Fig. 22.
- an interface for selecting inputs from a menu, which may invoke active GUI-based input elicitation as illustrated in Fig. 23.

**[0352]** One skilled in the art will recognize that other input modes may be provided.

**[0353]** In one embodiment, step 100 may include presenting options remaining from a previous conversation with assistant 1002, for example using

the techniques described in the active dialog suggestion input elicitation procedure described in connection with Fig. 24.

**[0354]** For example, by one of the methods of active input elicitation in step 100, the user might say to assistant 1002, “where may I get some good Italian around here?” For example, the user might have spoken this into a speech input component. An embodiment of an active input elicitation component 1094 calls a speech-to-text service, asks the user for confirmation, and then represents the confirmed user input as a uniform annotated input format 2690.

**[0355]** An embodiment of language interpreter component 1070 is then called in step 200, as described in connection with Fig. 29. Language interpreter component 1070 parses the text input and generates a list of possible interpretations of the user’s intent 290. In one parse, the word “italian” is associated with *restaurants of style Italian*; “good” is associated with the *recommendation property of restaurants*; and “around here” is associated with a location parameter describing a distance from a global sensor reading (for example, the user’s location as given by GPS on a mobile device).

**[0356]** In step 300, the representation of the user’s intent 290 is passed to dialog flow processor 1080, which implements an embodiment of a dialog and flow analysis procedure as described in connection with Fig. 32. Dialog flow processor 1080 determines which interpretation of intent is most likely, maps this interpretation to instances of domain models and parameters of a task model, and determines the next flow step in a dialog flow. In the current example, a restaurant domain model is instantiated with a constrained selection task to find a restaurant by constraints (the cuisine style, recommendation level, and proximity constraints). The dialog flow model indicates that the next step is to get some examples of restaurants meeting these constraints and present them to the user.

**[0357]** In step 400, an embodiment of the flow and service orchestration procedure 400 is invoked, via services orchestration component 1082. It in-

vokes a set of services 1084 on behalf of the user's request to find a restaurant. In one embodiment, these services 1084 contribute some data to a common result. Their data are merged and the resulting list of restaurants is represented in a uniform, service-independent form.

**[0358]** In step 500, output processor 1092 generates a dialog summary of the results, such as, "I found some recommended Italian restaurants near here." Output processor 1092 combines this summary with the output result data, and then sends the combination to a module that formats the output for the user's particular mobile device in step 600.

**[0359]** In step 700, this device-specific output package is sent to the mobile device, and the client software on the device renders it on the screen (or other output device) of the mobile device.

**[0360]** The user browses this presentation, and decides to explore different options. If the user is done 790, the method ends. If the user is not done 490, another iteration of the loop is initiated by returning to step 100.

**[0361]** The automatic call and response procedure may be applied, for example to a user's query "how about mexican food?". Such input may be elicited in step 100. In step 200, the input is interpreted as *restaurants of style Mexican*, and combined with the other state (held in short term personal memory 1052) to support the interpretation of the same intent as the last time, with one change in the restaurant style parameter. In step 300, this updated intent produces a refinement of the request, which is given to service orchestration component(s) 1082 in step 400.

**[0362]** In step 400 the updated request is dispatched to multiple services 1084, resulting in a new set of restaurants which are summarized in dialog in 500, formatted for the device in 600, and sent over the network to show new information on the user's mobile device in step 700.

**[0363]** In this case, the user finds a restaurant of his or her liking, shows it on a map, and sends directions to a friend.

**[0364]** One skilled in the art will recognize that different embodiments of the automated call and response procedure (not shown) may include additional features and/or operations than those illustrated in the specific embodiment of Fig. 33, and/or may omit at least a portion of the features and/or operations of automated call and response procedure illustrated in the specific embodiment of Fig. 33.

### ***Constrained Selection***

**[0365]** In one embodiment, intelligent automated assistant 1002 uses constrained selection in its interactions with the user, so as to more effectively identify and present items that are likely to be of interest to the user.

**[0366]** Constrained selection is a kind of generic task. Generic tasks are abstractions that characterize the kinds of domain objects, inputs, outputs, and control flow that are common among a class of tasks. A constrained selection task is performed by *selecting* items from a choice set of domain objects (such as restaurants) based on *selection constraints* (such as a desired cuisine or location). In one embodiment, assistant 1002 helps the user explore the space of possible choices, eliciting the user's constraints and preferences, presenting choices, and offering actions to perform on those choices such as to reserve, buy, remember, or share them. The task is complete when the user selects one or more items on which to perform the action.

**[0367]** Constrained selection is useful in many contexts: for example, picking a movie to see, a restaurant for dinner, a hotel for the night, a place to buy a book, or the like. In general, constrained selection is useful when one knows the category and needs to select an instance of the category with some desired properties.

**[0368]** One conventional approach to constrained selection is a directory service. The user picks a category and the system offers a list of choices. In a local directory, one may constrain the directory to a location, such as a city. For instance, in a "yellow pages" service, users select the book for a city and

then look up the category, and the book shows one or more items for that category. The main problem with a directory service is that the number of possibly relevant choices is large (e.g., restaurants in a given city).

**[0369]** Another conventional approach is a database application, which provides a way to generate a choice set by eliciting a query from the user, retrieving matching items, and presenting the items in some way that highlights salient features. The user browses the rows and columns of the result set, possibly sorting the results or changing the query until he or she finds some suitable candidates. The problem with the database service is that it may require the user to operationalize their human need as a formal query and to use the abstract machinery of sort, filter, and browse to explore the resulting data. These are difficult for most people to do, even with graphical user interfaces.

**[0370]** A third conventional approach is open-ended search, such as “local search”. Search is easy to do, but there are several problems with search services that make them difficult for people to accomplish the task of constrained selection. Specifically:

- As with directory search, the user may not just enter a category and look at one or more possible choice, but must narrow down the list.
- If the user can narrow the selection by constraints, it is not obvious *what* constraints may be used (e.g., may I search for places that are within walking distance or are open late?)
- It is not clear *how* to state constraints (e.g., is it called cuisine or restaurant type, and what are the possible values?)
- Multiple preferences conflict; there is usually no objectively “best” answer to a given situation (e.g., I want a place that is close by and cheap serving gourmet food with excellent service and which is open until midnight).
- Preferences are relative, and they depend on what is available. For example, if the user may get a table at a highly rated restaurant, he

or she might choose it even though it is expensive. In general, though, the user would prefer less expensive options.

**[0371]** In various embodiments, assistant 1002 of the present invention helps streamline the task of constrained selection. In various embodiments, assistant 1002 employs database and search services, as well as other functionality, to reduce the effort, on the part of the user, of stating what he or she is looking for, considering what is available, and deciding on a satisfactory solution.

**[0372]** In various embodiments, assistant 1002 helps to make constrained selection simpler for humans in any of a number of different ways.

**[0373]** For example, in one embodiment, assistant 1002 may operationalize properties into constraints. The user states what he or she wants in terms of *properties of the desired outcome*. Assistant 1002 operationalizes this input into formal constraints. For example, instead of saying “find one or more restaurants less than 2 miles from the center of Palo Alto whose cuisine includes Italian food” the user may just say “Italian restaurants in palo alto”. Assistant 1002 may also operationalize qualities requested by the user that are not parameters to a database. For example, if the user requests romantic restaurants, the system may operationalize this as a text search or tag matching constraint. In this manner, assistant 1002 helps overcome some of the problems users may otherwise have with constrained selection. It is easier, for a user, to imagine and describe a satisfactory solution than to describe conditions that would distinguish suitable from unsuitable solutions.

**[0374]** In one embodiment, assistant 1002 may suggest useful selection criteria, and the user need only say which criteria are important at the moment. For example, assistant 1002 may ask “which of these matter: price (cheaper is better), location (closer is better), rating (higher rated is better)?” Assistant 1002 may also suggest criteria that may require specific values; for example, “you can say what kind of cuisine you would like or a food item you would like”.

**[0375]** In one embodiment, assistant 1002 may help the user make a decision among choices that differ on a number of competing criteria (for example, price, quality, availability, and convenience).

**[0376]** By providing such guidance, assistant 1002 may help users in making multiparametric decisions in any of several ways:

- One is to *reduce the dimensionality* of the space, combining raw data such as ratings from multiple sources into a composite “recommendation” score. The composite score may take into account domain knowledge about the sources of data (e.g., Zagat ratings may be more predictive of quality than Yelp).
- Another approach is to *focus on a subset of criteria*, turning a problem of “what are all the possible criteria to consider and how to they combine?” into a selection of the most important criteria in a given situation (e.g., “which is more important, price or proximity?”).
- Another way to simplify the decision making is to *assume default values and preference orders* (e.g., all things being equal, higher rated and closer and cheaper are better). The system may also remember users’ previous responses that indicate their default values and preferences.
- Fourth, the system may offer salient properties of items in the choice set that were not mentioned in the original request. For example, the user may have asked for local Italian food. The system may offer a choice set of restaurants, and with them, a list of popular tags used by reviewers or a tag line from a guide book (e.g., “a nice spot for a date” “great pasta”). This could let people pick out a specific item and complete the task. Research shows that most people make decisions by evaluating specific instances rather than deciding on criteria and rationally accepting the one that pops to the top. It also shows that people learn about features from concrete cases. For example, when choosing among cars, buyers may

not care about navigation systems until they see that some of the cars have them (and then the navigation system may become an important criterion). Assistant 1002 may present salient properties of listed items that help people pick a winner or that suggest a dimension along which to optimize.

### ***Conceptual Data Model***

**[0377]** In one embodiment, assistant 1002 offers assistance with the constrained selection task by simplifying the conceptual data model. The conceptual data model is the abstraction presented to users in the interface of assistant 1002. To overcome the psychological problems described above, in one embodiment assistant 1002 provides a model that allows users to describe what they want in terms of a few easily recognized and recalled properties of suitable choices rather than constraint expressions. In this manner, properties can be made easy to compose in natural language requests (e.g., adjectives modifying keyword markers) and be recognizable in prompts (“you may also favor *recommended* restaurants...”). In one embodiment, a data model is used that allows assistant 1002 to determine the domain of interest (e.g., restaurants versus hotels) and a general approach to guidance that may be instantiated with domain-specific properties.

**[0378]** In one embodiment, the conceptual data model used by assistant 1002 includes a selection class. This is a representation of the space of things from which to choose. For example, in the find-a-restaurant application, the selection class is the class of restaurants. The selection class may be abstract and have subclasses, such as “things to do while in a destination”. In one embodiment, the conceptual data model assumes that, in a given problem solving situation, the user is interested in choosing from a single selection class. This assumption simplifies the interaction and also allows assistant 1002 to declare its boundaries of competence (“I know about restaurants, hotels, and movies” as opposed to “I know about life in the city”).



**[0379]** Given a selection class, in one embodiment the data model presented to the user for the constrained selection task includes, for example: items; item features; selection criteria; and constraints.

**[0380]** **Items** are instances of the selection class.

**[0381]** **Item features** are properties, attributes, or computed values that may be presented and/or associated with at least one item. For example, the name and phone number of a restaurant are item features. Features may be intrinsic (the name or cuisine of a restaurant) or relational (e.g., the distance from one's current location of interest). They may be static (e.g., restaurant name) or dynamic (rating). They may be composite values computed from other data (e.g., a "value for money" score). Item features are abstractions for the user made by the domain modeler; they do not need to correspond to underlying data from back-end services.

**[0382]** **Selection criteria** are item features that may be used to compare the value or relevance of items. That is, they are ways to say which items are preferred. Selection criteria are modeled as features of the items themselves, whether they are intrinsic properties or computed. For example, *proximity* (defined as distance from the location of interest) is a selection criterion. *Location in space-time* is a property, not a selection criterion, and it is used along with the location of interest to compute the distance from the location of interest.

**[0383]** Selection criteria may have an inherent preference order. That is, the values of any particular criterion may be used to line up items in a best first order. For example, the proximity criterion has an inherent preference that closer is better. Location, on the other hand, has no inherent preference value. This restriction allows the system to make default assumptions and guide the selection if the user only *mentions* the criterion. For example, the user interface might offer to "sort by rating" and assume that higher rated is better.

**[0384]** One or more selection criteria are also item features; they are those features related to choosing among possible items. However, item features are not necessarily related to a preference (e.g., the names and phone numbers of restaurants are usually irrelevant to choosing among them).

**[0385]** In at least one embodiment, **constraints** are restrictions on the desired values of the selection criteria. Formally, constraints might be represented as set membership (e.g., cuisine type includes Italian), pattern matches (e.g., restaurant review text includes “romantic”), fuzzy inequalities (e.g., distance less than a few miles), qualitative thresholds (e.g., highly rated), or more complex functions (e.g., a good value for money). To make things simple enough for normal humans, this data model reduces at least one or more constraints to symbolic values that may be matched as words. Time and distance may be excluded from this reduction. In one embodiment, the operators and threshold values used for implementing constraints are hidden from the user. For example, a constraint on the selection criteria called “cuisine” may be represented as a symbolic value such as “Italian” or “Chinese”. A constraint on rating is “recommended” (a binary choice). For time and distance, in one embodiment assistant 1002 uses proprietary representations that handle a range of inputs and constraint values. For example, distance might be “walking distance” and time might be “tonight”; in one embodiment, assistant 1002 uses special processing to match such input to more precise data.

**[0386]** In at least one embodiment, some constraints may be **required constraints**. This means that the task simply cannot be completed without this data. For example, it is hard to pick a restaurant without some notion of desired location, even if one knows the name.

**[0387]** To summarize, a domain is modeled as selection classes with item features that are important to users. Some of the features are used to select and order items offered to the user - these features are called selection criteria. Constraints are symbolic limits on the selection criteria that narrow the set of items to those that match.

**[0388]** Often, multiple criteria may compete and constraints may match partially. The data model reduces the selection problem from an optimization (finding the best solution) to a matching problem (finding items that do well on a set of specified criteria and match a set of symbolic constraints). The algorithms for selecting criteria and constraints and determining an ordering are described in the next section.

### ***Methodology for Constrained Selection***

**[0389]** In one embodiment, assistant 1002 performs constrained selection by taking as input an ordered list of criteria, with implicit or explicit constraints on at least one, and generating a set of candidate items with salient features. Computationally, the selection task may be characterized as a nested search: first, identify a selection class, then identify the important selection criteria, then specify constraints (the boundaries of acceptable solutions), and search through instances in order of best-fit to find acceptable items.

**[0390]** Referring now to Fig. 45, there is shown an example of an abstract model 4500 for a constrained selection task as a nested search. In the example assistant 1002 identifies 4505 a selection call among all local search types 4501. The identified class is restaurant. Within the set of all restaurants 4502, assistant 1002 selects 4506 criteria. In the example, the criterion is identified as distance. Within the set of restaurants in PA 4503, assistant 1002 specifies 4507 constraints for the search. In the example, the identified constraint is “Italian cuisine”). Within the set of Italian restaurants in PA 4504, assistant 4508 selects items for presentation to the user.

**[0391]** In one embodiment, such a nested search is what assistant 1002 does once it has the relevant input data, rather than the flow for eliciting the data and presenting results. In one embodiment, such control flow is governed via a dialog between assistant 1002 and the user which operates by other procedures, such as dialog and task flow models. Constrained selection

offers a framework for building dialog and task flow models at this level of abstraction (that is, suitable for constrained selection tasks regardless of domain).

**[0392]** Referring now to Fig. 46, there is shown an example of a dialog 4600 to help guide the user through a search process, so that the relevant input data can be obtained.

**[0393]** In the example dialog 4600, the first step is for the user to state the kind of thing they are looking for, which is the selection class. For example, the user might do this by saying “dining in palo alto”. This allows assistant 1002 to infer 4601 the task and domain.

**[0394]** Once assistant 1002 has understood the task and domain binding (selection class = restaurants), the next step is to understand which selection criteria are important to this user, for example by soliciting 4603 criteria and/or constraints. In the example above, “in palo alto” indicates a location of interest. In the context of restaurants, the system may interpret a location as a proximity constraint (technically, a constraint on the proximity criterion). Assistant 1002 explains what is needed, receives input. If there is enough information to constrain the choice set to a reasonable size, then assistant 1002 paraphrases the input and presents 4605 one or more restaurants that meet the proximity constraint, sorted in some useful order. The user can then select 4607 from this list, or refine 4606 the criteria and constraints. Assistant 1002 reasons about the constraints already stated, and uses domain-specific knowledge to suggest other criteria that might help, soliciting constraints on these criteria as well. For example, assistant 1002 may reason that, when recommending restaurants within walking distance of a hotel, the useful criteria to solicit would be cuisine and table availability.

**[0395]** The constrained selection task is complete when the user selects 4607 an instance of the selection class. In one embodiment, additional follow-on tasks 4602 are enabled by assistant 1002. Thus, assistant 1002 can offer services that indicate selection while providing some other value. Examples

4608 booking a restaurant, setting a reminder on a calendar, and/or sharing the selection with others by sending an invitation. For example, booking a restaurant certainly indicates that it was selected; other options might be to put the restaurant on a calendar or send in invitation with directions to friends.

**[0396]** Referring now to Fig. 47, there is shown a flow diagram depicting a method of constrained selection according to one embodiment. In one embodiment, assistant 1002 operates in an opportunistic and mixed-initiative manner, permitting the user to jump to the inner loop, for instance, by stating task, domain, criteria, and constraints one or more at once in the input.

**[0397]** The method begins 4701. Input is received 4702 from the user, according to any of the modes described herein. If, based on the input, the task not known, assistant 1002 requests 4705 clarifying input from the user.

**[0398]** In step 4717, assistant 1002 determines whether the user provides additional input. If so, assistant 1002 returns to step 4702. Otherwise the method ends 4799.

**[0399]** If, in step 4703, the task is known, assistant 1002 determines 4704 whether the task is constrained selection. If not, assistant 1002 proceeds 4706 to the specified task flow.

**[0400]** If, in step 4704, the task is constrained selection, assistant 1002 determines 4707 whether the selection class can be determined. If not, assistant 1002 offers 4708 a choice of known selection classes, and returns to step 4717.

**[0401]** If, in step 4707, the selection class can be determined, assistant 1002 determines 4709 whether all required constraints can be determined. If not, assistant 1002 prompts 4710 for required information, and returns to step 4717.

**[0402]** If, in step 4709, all required constants can be determined, assistant 1002 determines 4711 whether any result items can be found, given the constraints. If there are no items that meet the constraints, assistant 1002 offers 4712 ways to relax the constraints. For example, assistant 1002 may relax the

constraints from lowest to highest precedence, using a filter/sort algorithm. In one embodiment, if there are items that meet *some* of the constraints, then assistant 1002 may paraphrase the situation (outputting, for example, “I could not find Recommended Greek restaurants that deliver on Sundays in San Carlos. However, I found 3 Greek restaurants and 7 Recommend restaurants in San Carlos.”). In one embodiment, if there are no items that match *any* constraints, then assistant 1002 may paraphrase this situation and prompt for different constraints (outputting, for example, “Sorry, I could not find any restaurants in Anytown, Texas. You may pick a different location.”). Assistant 1002 returns to step 4717.

**[0403]** If, in step 4711, result items can be found, assistant 1002 offers 4713 a list of items. In one embodiment, assistant 1002 paraphrases the currently specified criteria and constraints (outputting, for example, “Here are some recommended Italian restaurants in San Jose.” (recommended=yes, cuisine=Italian, proximity=<in San Jose>)). In one embodiment, assistant 1002 presents a sorted, paginated list of items that meet the known constraints. If an item only shows some of the constraints, such a condition can be shown as part of the item display. In one embodiment, assistant 1002 offers the user ways to select an item, for example by initiating another task on that item such as booking, remembering, scheduling, or sharing. In one embodiment, on any given item, assistant 1002 presents item features that are salient for picking instances of the selection class. In one embodiment, assistant 1002 shows how the item meets a constraint; for example, Zagat rating of 5 meets the Recommended=yes constraint, and “1 mile away” meets the “within walking distance of an address” constraint. In one embodiment, assistant 1002 allows the user to drill down for more detail on an item, which results in display of more item features.

**[0404]** Assistant 1002 determines 4714 whether the user has selected an item. If the user selects an item, the task is complete. Any follow-on task is performed 4715, if there is one, and the method ends 4799.

**[0405]** If, in step 4714, the user does not select an item, assistant 1002 offers 4716 the user ways to select other criteria and constraints and returns to step 4717. For example, given the currently specified criteria and constraints, assistant 1002 may offer criteria that are most likely to constrain the choice set to a desired size. If the user selects a constraint value, that constraint value is added to the previously determined constraints when steps 4703 to 4713 are repeated.

**[0406]** Since one or more criteria may have an inherent preference value, selecting the criteria may add information to the request. For example, allowing the user to indicate that positive reviews are valued allows assistant 1002 to sort by this criterion. Such information can be taken into account when steps 4703 to 4713 are repeated.

**[0407]** In one embodiment, assistant 1002 allows the user to raise the importance of a criterion that is already specified, so that it would be higher in the precedence order. For example, if the user asked for fast, cheap, highly recommended restaurants within one block of their location, assistant 1002 may request that the user chooses which of these criteria are more important. Such information can be taken into account when steps 4703 to 4713 are repeated.

**[0408]** In one embodiment, the user can provide additional input at any point while the method of Fig. 47 is being performed. In one embodiment, assistant 1002 checks periodically or continuously for such input, and, in response, loops back to step 4703 to process it.

**[0409]** In one embodiment, when outputting an item or list of items, assistant 1002 indicates, in the presentation of items, the features that were used to select and order them. For example, if the user asked for nearby Italian restaurants, such item features for distance and cuisine may be shown in the presentation of the item. This may include highlighting matches, as well as listing selection criteria that were involved in the presentation of an item.

### Example Domains

**[0410]** Table 1 provides an example of constrained selection domains that may be handled by assistant 1002 according to various embodiments.

Select a	Based on these criteria								
	Location	Price	Availability	Type	Quality	Name	Services	special search	general search
Restaurant	proximity	affordability	open tables	cuisine	rating by guide, re- view	restaurant name	delivery	menu items	keywords
Hotel	proximity	price range	available rooms	motel, ho- tel, B&B, ...	rating by guide, re- view	hotel name	amenities		keywords
Movie	theatre proximity		show times	genre	rating by review	movie title		actors, etc	
Local Business	proximity			business category	rating by review	business name			keywords
Local event	venue proximity		by date			event title			keywords
concert	venue proximity		by tour schedule	music genre		band name		band members	keywords
CD, book, DVD to buy		price range	online, in store, etc	download, physical	popularity	album or song name		artist, title, etc.	keywords

Table 1

### Filtering and Sorting Results

**[0411]** In one embodiment, when presenting items that meet currently specified criteria and constraints, a filter/sort methodology can be employed. In one embodiment selection constraints may serve as both filter and sort parameters to the underlying services. Thus, any selection criterion can be used



to determine *which* items are in the list, and to compute the order in which to paginate and show them. Sort order for this task is akin to relevance rank in search. For example, proximity is a criterion with symbolic constraint values such as “within driving distance” and a general notion of sorting by distance. The “driving distance” constraint might be used to select a group of candidate items. Within that group, closer items might be sorted higher in the list.

**[0412]** In one embodiment, selection constraints and associated filtering and sorting are at discrete “levels”, which are functions of both the underlying data and the input from the user. For example, proximity is grouped into levels such as “walking distance”, “taxi distance”, “driving distance”. When sorting, one or more items within walking distance are treated as if they were the *same* distance. The input from the user may come into play in the way he or she specifies a constraint. If the user enters “in palo alto”, for example, then one or more items within the Palo Alto city limits are perfect matches and are equivalent. If the user enters, “near the University Avenue train station” then the match would depend on a distance from that address, with the degree of match dependent on the selection class (e.g., near for restaurants is different than near for hotels). Even within a constraint that *may* be specified with a continuous value, a discretization may be applied. This may be important for sorting operations, so that multiple criteria may participate in determining the best-first ordering.

**[0413]** In one embodiment, the item list -- those items that are considered “matching” or “good enough” -- may be shorter or longer than the number of items shown on one “page” of the output. Generally, items in the first page are given the most attention, but conceptually there is a longer list, and pagination is simply a function of the form factor of the output medium. This means, for instance, that if the user is offered a way to sort or browse the items by some criterion, then it is the entire set of items (more than one page worth) that is sorted or browsed.

**[0414]** In one embodiment, there is a precedence ordering among selection criteria. That is, some criteria may matter more than others in the filter and sort. In one embodiment, those criteria selected by the user are given higher precedence than others, and there is a default ordering over one or more criteria. This allows for a general lexicographic sort. The assumption is that there is a meaningful *a priori* precedence. For example, unless the user states otherwise, it may be more important for a restaurant to be close than to be inexpensive. In one embodiment, the *a priori* precedence ordering is domain-specific. The model allows for user-specific preferences to override the domain defaults, if that is desired.

**[0415]** Since the values of constraints can represent several internal data types, there are different ways for constraints to match, and they may be specific to the constraint. For example, in one embodiment:

- Binary constraints match one or more or none. For example, whether a restaurant is “Fast” might be either true or not.
- Set membership constraints match one or more or none based on a property value. For example, cuisine=Greek means the set of cuisines for a restaurant includes Greek.
- Enumeration constraints match at a threshold. For example, a rating criterion might have constraint values rated, highly-rated, or top-rated. Constraining to highly-rated would also match top-rated.
- Numeric constraints match at a threshold that may be criterion specific. For example, “open late” might be a criterion, and the user might ask for places open after 10:00pm. This kind of constraint may be slightly out of scope for the constrained selection task, since it is not a symbolic constraint value. However, in one embodiment, assistant 1002 recognizes some cases of numeric constraints like this, and maps them to threshold values with symbolic constraints

(e.g., “restaurants in palo alto open now” -> “here are 2 restaurants in palo alto that are open late”).

- Location and time are handled specially. A constraint on proximity might be a location of interest specified at some level of granularity, and that determines the match. If the user specifies a city, then city-level matching is appropriate; a ZIP code may allow for a radius. Assistant 1002 may also understand locations that are “near” other locations of interest, also based on special processing. Time is relevant as a constraint value of criteria that have threshold value based on a service call, such as table availability or flights within a given time range.

**[0416]** In one embodiment, constraints can be modeled so that there is a single threshold value for selection and a small set of discrete values for sorting. For example, the *affordability* criterion might be modeled as a roughly binary constraint, where affordable restaurants are any under some threshold price range. When the data justify multiple discrete levels for selection, constraints can be modeled using a gradient of matching. In one embodiment two levels of matching (such as strong and weak matching) may be provided; however, one skilled in the art will recognize that in other embodiments, any number of levels of matching can be provided. For example, proximity may be matched with a fuzzy boundary, so that things that are near the location of interest may match weakly. The operational consequence of a strong or weak match is in the filter/sort algorithm as described below.

**[0417]** For at least one criterion, an approach to matching and default thresholds can be established, if relevant. The user may be able to say just the name of the constraint, a symbolic constraint value, or a precise constraint expression if it is handled specially (such as time and location).

**[0418]** An ideal situation for constrained selection occurs when the user states constraints that result in a short list of candidates, one or more of which meet the constraints. The user then chooses among winners based on item

features. In many cases, however, the problem is over- or under-constrained. When it is over-constrained, there are few or no items that meet the constraints. When it is under-constrained, there are so many candidates that examining the list is not expedient. In one embodiment, the general constrained selection model of the present invention is able to handle multiple constraints with robust matching and usually produce *something* to choose from. Then the user may elect to refine their criteria and constraints or just complete the task with a “good enough” solution.

### *Method*

**[0419]** In one embodiment, the following method is used for filtering and sorting results:

1. Given an ordered list of selection criteria selected by the user, determine constraints on at least one.
  - a. If the user specified a constraint value, use it. For example, if the user said “greek food” the constraint is cuisine=Greek. If the user said “san Francisco” the constraint is *In the City of San Francisco*. If the user said “south of market” then the constraint is *In the Neighborhood of SoMa*.
  - b. Otherwise use a domain- and criteria-specific default. For example, if the user said “a table at some thai place” he or she is indicating that the *availability* criterion is relevant, but he or she did not specify a constraint value. The default constraint values for availability might be some range of date times such as *tonight* and a default party size of 2.
2. Select a minimum of N results by specified constraints.
  - a. Try to get N results at strong match.
  - b. If that fails, try to relax constraints, in reverse precedence order. That is, match at strong level for one or more of the criteria except the last, which may match at a weak level. If there is no

weak match for that constraint, then try weak matches up the line from lowest to highest precedence.

- c. Then repeat the loop allowing failure to match on constraints, from lowest to highest precedence.
3. After getting a minimum choice set, sort lexicographically over one or more criteria (which may include user-specified criteria as well as other criteria) in precedence order.
    - a. Consider the set of user-specified criteria as highest precedence, then one or more remaining criteria in their *a priori* precedence. For example, if the *a priori* precedence is (availability, cuisine, proximity, rating), and the user gives constraints on proximity and cuisine, then the sort precedence is (cuisine, proximity, availability, rating).
    - b. Sort on criteria using discrete match levels (strong, weak, none), using the same approach as in relaxing constraints, this time applied the full criteria list.
      - i. If a choice set was obtained without relaxing constraints, then one or more of the choice set may “tie” in the sort because they one or more match at strong levels. Then, the next criteria in the precedence list may kick in to sort them. For example, if the user says *cuisine=Italian*, *proximity=In San Francisco*, and the sort precedence is (cuisine, proximity, availability, rating), then one or more the places on the list have equal match values for cuisine and proximity. So the list would be sorted on availability (places with tables available bubble to the top). Within the available places, the highest rated ones would be at the top.
      - ii. If the choice set was obtained by relaxing constraints, then one or more of the fully matching items are at the

top of the list, then the partially matching items. Within the matching group, they are sorted by the remaining criteria, and the same for the partially matching group. For example, if there were only two Italian restaurants in San Francisco, then the available one would be shown first, then the unavailable one. Then the rest of the restaurants in San Francisco would be shown, sorted by availability and rating.

### *Precedence Ordering*

**[0420]** The techniques described herein allow assistant 1002 to be extremely robust in the face of partially specified constraints and incomplete data. In one embodiment, assistant 1002 uses these techniques to generate a user list of items in best-first order, i.e. according to relevance.

**[0421]** In one embodiment, such relevance sorting is based on an *a priori* precedence ordering. That is, of the things that matter about a domain, a set of criteria is chosen and placed in order of importance. One or more things being equal, criteria higher in the precedence order may be more relevant to a constrained selection among items than those lower in the order. Assistant 1002 may operate on any number of criteria. In addition, criteria may be modified over time without breaking existing behaviors.

**[0422]** In one embodiment, the precedence order among criteria may be tuned with domain-specific parameters, since the way criteria interact may depend on the selection class. For example, when selecting among hotels, availability and price may be dominant constraints, whereas for restaurants, cuisine and proximity may be more important.

**[0423]** In one embodiment, the user may override the default criteria ordering in the dialog. This allows the system to guide the user when searches are over-constrained, by using the ordering to determine which constraints should be relaxed. For example, if the user gave constraints on cuisine, proximity, recommendation, and food item, and there were no fully matching

items, the user could say that food item was more important than recommendation level and change the mix so the desired food item matches were sorted to the top.

**[0424]** In one embodiment, when precedence order is determined, user-specified constraints take precedence over others. For example, in one embodiment, proximity is a required constraint and so is always specified, and further has precedence over other unselected constraints. Therefore it does not have to be the highest precedence constraint in order to be fairly dominant. Also, many criteria may not match at one or more unless a constraint is given by the user, and so the precedence of these criteria only matters within user-selected criteria. For example, when the user specifies a cuisine it is important to them, and otherwise is not relevant to sorting items.

**[0425]** For example, the following is a candidate precedence sorting paradigm for the restaurant domain:

1. cuisine\* (not sortable unless a constraint value is given)
2. availability\* (sortable using a *default* constraint value, e.g., time)
3. recommended
4. proximity\* (a constraint value is always given)
5. affordability
6. may deliver
7. food item (not sortable unless a constraint value, e.g., a keyword, is given)
8. keywords (not sortable unless a constraint value, e.g., a keyword, is given)
9. restaurant name

**[0426]** The following is an example of a design rationale for the above sorting paradigm:

- If a user specifies a cuisine, he or she wants it to stick.

- One or more things being equal, sort by rating level (it is the highest precedence among criteria than may be used to sort without a constraint).
- In at least one embodiment, proximity may be more important than most things. However, since it matches at discrete levels (in a city, within a radius for walking and the like), and it is always specified, then most of the time most matching items may “tie” on proximity.
- Availability (as determined by a search on a website such as open-table.com, for instance) is a valuable sort criterion, and may be based on a default value for sorting when not specified. If the user indicates a time for booking, then only available places may be in the list and the sort may be based on recommendation.
- If the user says they want highly recommended places, then it may sort above proximity and availability, and these criteria may be relaxed before recommendation. The assumption is that if someone is looking for nice place, they may be willing to drive a bit farther and it is more important than a default table availability. If a specific time for availability is specified, and the user requests recommended places, then places that are both recommended and available may come first, and recommendation may relax to a weak match before availability fails to match at one or more.
- The remaining constraints except for name are one or more based on incomplete data or matching. So they are weak sort heuristics by default, and when they are specified the match one or more-or-none.
- Name may be used as a constraint to handle the case where someone mentions the restaurant by name, e.g., find one or more Hobe’s restaurants near Palo Alto. In this case, one or more items may match the name, and may be sorted by proximity (the other specified constraint in this example).



***Domain Modeling: Mapping Selection Criteria to underlying data***

**[0427]** It may be desirable to distinguish between the data that are available for computation by assistant 1002 and the data used for making selections. In one embodiment, assistant 1002 uses a data model that reduces the complexity for the user by folding one or more kinds of data used to distinguish among items into a simple selection criteria model. Internally, these data may take several forms. Instances of the selection class can have intrinsic properties and attributes (such as cuisine of a restaurant), may be compared along dimensions (such as the distance from some location), and may be discovered by some query (such as whether it matches a text pattern or is available at a given time). They may also be computed from other data which are not exposed to the user as selection criteria (e.g., weighted combinations of ratings from multiple sources). These data are one or more relevant to the task, but the distinctions among these three kinds of data are not relevant to the user. Since the user thinks in terms of features of the desired choice rather than in properties and dimensions, assistant 1002 operationalizes these various criteria into features of the items. Assistant 1002 provides a user-facing domain data model and maps it to data found in web services.

**[0428]** One type of mapping is an isomorphism from underlying data to user-facing criteria. For example, the availability of tables for reservations as seen by the user could be exactly what an online reservation website, such as opentable.com, offers, using the same granularity for time and party size.

**[0429]** Another type of mapping is a normalization of data from one or more services to a common value set, possibly with a unification of equivalent values. For example, cuisines of one or more restaurants may be represented as a single ontology in assistant 1002, and mapped to various vocabularies used in different services. That ontology might be hierarchical, and have leaf nodes pointing to specific values from at least one service. For example, one service might have a cuisine value for “Chinese”, another for “Szechuan”, and a third for “Asian”. The ontology used by assistant 1002 would cause refer-

ences to “Chinese food” or “Szechuan” to semantically match one or more of these nodes, with confidence levels reflecting the degree of match.

**[0430]** Normalization might also be involved when resolving differences in precision. For example, the location of a restaurant may be given to the street level in one service but only to city in another. In one embodiment, assistant 1002 uses a deep structural representation of locations and times that may be mapped to different surface data values.

**[0431]** In one embodiment, assistant 1002 uses a special kind of mapping for open-ended qualifiers (e.g., romantic, quiet) which may be mapped to matches in full text search, tags, or other open-textured features. The name of the selection constraint in this case would be something like “is described as”.

**[0432]** In at least one embodiment, constraints may be mapped to operational preference orderings. That is, given the name of a selection criterion and its constraint value, assistant 1002 is able to interpret the criterion as an ordering over possible items. There are several technical issues to address in such a mapping. For example:

- Preference orderings may conflict. The ordering given by one constraint may be inconsistent or even inversely correlated with the ordering given by another. For example, price and quality tend to be in opposition. In one embodiment, assistant 1002 interprets constraints chosen by the user in a weighted or otherwise combined ordering that reflects the user’s desires but is true to the data. For example, the user may ask for “cheap fast food French restaurants within walking distance rated highly”. In many locations, there may not be any such restaurant. However, in one embodiment, assistant 1002 may show a list of items that tries to optimize for at least one constraint, and explain why at least one is listed. For example, item one might be “highly rated French cuisine” and another “cheap fast food within walking distance”.

- Data may be used as either hard or soft constraints. For example, the price range of a restaurant may be important to choosing one, but it may be difficult to state a threshold value for price up-front. Even seemingly hard constraints like cuisine may be, in practice, soft constraints because of partial matching. Since, in one embodiment, assistant 1002 using a data modeling strategy that seeks to flatten one or more criteria into symbolic values (such as “cheap” or “close”), these constraints may be mapped into a function that gets the *criteria* and *order* right, without being strict about matching specific threshold values. For symbolic criteria with clear objective truth values, assistant 1002 may weight the objective criteria higher than other criteria, and make it clear in the explanation that it knows that some of the items do not strictly match the requested criteria.
- Items may match some but not one or more constraints, and the “best fitting” items may be shown.
- In general, assistant 1002 determines which item features are salient for a domain, and which may serve as selection criteria, and for at least one criteria, possible constraint values. Such information can be provided, for example, via operational data and API calls.

### ***Paraphrase and Prompt Text***

**[0433]** As described above, in one embodiment assistant 1002 provides feedback to show it understands the user’s intent and is working toward the user’s goal by producing paraphrases of its current understanding. In the conversational dialog model of the present invention, the paraphrase is what assistant 1002 outputs after the user’s input, as a preface (for example, paraphrase 4003 in Fig. 40) or summary of the results to follow (for example, list 3502 in Fig. 35). The prompt is a suggestion to the user about what else they

can do to refine their request or explore the selection space along some dimensions.

**[0434]** In one embodiment, the purposes of paraphrase and prompt text include, for example:

- to show that assistant 1002 understands the concepts in the user's input, not just the text;
- to indicate the boundaries of assistant's 1002 understanding;
- to guide the user to enter text that is required for the assumed task;
- to help the user explore the space of possibilities in constrained selection;
- to explain the current results obtained from services in terms of the user's stated criteria and assistant's 1002 assumptions (for example, to explain the results of under- and over-constrained requests).

**[0435]** For example, the following paraphrase and prompt illustrates several of these goals:

**User input:** indonesian food in menlo park

**System interpretation:**

Task=constrainedSelection

SelectionClass=restaurant

Constraints:

Location=Menlo Park, CA

Cuisine=Indonesian (known in ontology)

**Results from Services:** no strong matches

**Paraphrase:** Sorry, I can't find any Indonesian restaurants near Menlo Park.

**Prompt:** You could try other cuisines or locations.

**Prompt under hypertext links:**

Indonesian: You can try other food categories such as Chinese, or a favorite food item such as steak.

Menlo Park: Enter a location such as a city, neighborhood, street address, or “near” followed by a landmark.

Cuisines: Enter a food category such as Chinese or Pizza.

Locations: Enter a location: a city, zip code, or “near” followed by the name of a place.

**[0436]** In one embodiment, assistant 1002 responds to user input relatively quickly with the paraphrase. The paraphrase is then updated after results are known. For example, an initial response may be “Looking for Indonesian restaurants near Menlo Park...” Once results are obtained, assistant 1002 would update the text to read, “Sorry, I can’t find any Indonesian restaurants near Menlo Park. You could try other cuisines or locations.” Note that certain items are highlighted (indicated here by underline), indicating that those items represent constraints that can be relaxed or changed.

**[0437]** In one embodiment, special formatting/highlighting is used for key words in the paraphrase. This can be helpful to facilitate training of the user for interaction with intelligent automated assistant 1002, by indicating to the user which words are most important to, and more likely to be recognized by, assistant 1002. User may then be more likely to use such words in the future.

**[0438]** In one embodiment, paraphrase and prompt are generated using any relevant context data. For example, any of the following data items can be used, alone or in combination:

- The parse - a tree of ontology nodes bound to their matching input tokens, with annotations and exceptions. For each node in the parse, this may include the node’s metadata and/or any tokens in the input that provide evidence for the node’s value.
- The task, if known
- The selection class.

- The location constraint, independent of selection class.
- Which *required* parameters are unknown for the given selection class (e.g., location is a required constraint on restaurants).
- The name of a named entity in the parse that is an instance of the selection class, if there is one (e.g., a specific restaurant or movie name.)
- Is this a follow-up refinement or the beginning of a conversation? (Reset starts a new conversation.)
- Which constraints in the parse are bound to values in the input that changed their values? In other words, which constraints were just changed by the latest input?
- Is the selection class inferred or directly stated?
- Sorted by quality, relevance, or proximity?
- For each constraint specified, how well was it matched?
- Was refinement entered as text or clicking?

**[0439]** In one embodiment, the paraphrase algorithm accounts for the query, domain model 1056, and the service results. Domain model 1056 contains classes and features including metadata that is used to decide how to generate text. Examples of such metadata for paraphrase generation include:

- IsConstraint={true | false}
- IsMultiValued={true | false}
- ConstraintType={EntityName, Location, Time, CategoryConstraint, AvailabilityConstraint, BinaryConstraint, SearchQualifier, Gues-  
edQualifier}
- DisplayName=string
- DisplayTemplateSingular=string
- DisplayTemplatePlural=string
- Grammatical-  
Role={AdjectiveBeforeNoun,Noun,ThatClauseModifer}

**[0440]** For example, a parse might contain these elements:

**Class: Restaurant**

IsConstraint=false

DisplayTemplateSingular="restaurant"

DisplayTemplatePlural="restaurants"

GrammaticalRole=Noun

**Feature: RestaurantName** (example: "Il Fornaio")

IsConstraint=true

IsMultiValued=false

ConstraintType=EntityName

DisplayTemplateSingular="named \$1"

DisplayTemplatePlural="named \$1"

GrammaticalRole=Noun

**Feature: RestaurantCuisine** (example: "Chinese")

IsConstraint=true

IsMultiValued=false

ConstraintType= CategoryConstraint

GrammaticalRole=AdjectiveBeforeNoun

**Feature: RestaurantSubtype** (example: "café")

IsConstraint=true

IsMultiValued=false

ConstraintType= CategoryConstraint

DisplayTemplateSingular="\$1"

DisplayTemplatePlural="\$1s"

GrammaticalRole=Noun

**Feature: RestaurantQualifiers** (example: "romantic")

IsConstraint=true

IsMultiValued=true  
ConstraintType=SearchQualifier  
DisplayTemplateSingular="is described as \$1"  
DisplayTemplatePlural="are described as \$1"  
DisplayTemplateCompact="matching \$1"  
GrammaticalRole=Noun

Feature: **FoodType** (example: "burritos")

IsConstraint=true  
IsMultiValued=false  
ConstraintType= SearchQualifier  
DisplayTemplateSingular="serves \$1"  
DisplayTemplatePlural="serve \$1"  
DisplayTemplateCompact="serving \$1"  
GrammaticalRole=ThatClauseModifer

Feature: **IsRecommended** (example: true)

IsConstraint=true  
IsMultiValued=false  
ConstraintType= BinaryConstraint  
DisplayTemplateSingular="recommended"  
DisplayTemplatePlural="recommended"  
GrammaticalRole=AdjectiveBeforeNoun

Feature: **RestaurantGuessedQualifiers** (example: "spectacular")

IsConstraint=true  
IsMultiValued=false  
ConstraintType= GuessedQualifier  
DisplayTemplateSingular="matches \$1 in reviews"  
DisplayTemplatePlural="match \$1 in reviews"



DisplayTemplateCompact="matching \$1"  
GrammaticalRole=ThatClauseModifer

**[0441]** In one embodiment, assistant 1002 is able to handle unmatched input. To handle such input, domain model 1056 can provide for nodes of type GussedQualifier for each selection class, and rules that match otherwise unmatched words if they are in the right grammatical context. That is, GussedQualifiers are treated as miscellaneous nodes in the parse which match when there are words that are not found in the ontology but which are in the right context to indicate that that are probably qualifiers of the selection class. The difference between GussedQualifiers and SearchQualifiers is that the latter are matched to vocabulary in the ontology. This distinction allows us to paraphrase that assistant 1002 identified the intent solidly on the SearchQualifiers and can be more hesitant when echoing back the GussedQualifiers.

**[0442]** In one embodiment, assistant 1002 performs the following steps when generating paraphrase text:

1. If the task is unknown, explain what assistant 1002 can do and prompt for more input.
2. If the task is a constrained selection task and the location is known, then explain the domains that assistant 1002 knows and prompt for the selection class.
3. If the selection class is known but a required constraint is missing, then prompt for that constraint. (for example, location is required for constrained selection on restaurants)
4. If the input contains an EntityName of the selection class, then output "looking up" <name> in <location>.
5. If this is the initial request in a conversation, then output "looking for" followed by the complex noun phrase that describes the constraints.
6. If this is a follow-up refinement step in the dialog,

- a. If the user just completed a *required* input, then output “thanks” and then paraphrase normally. (This happens when there is a required constraint that is mapped to the user input.)
  - b. If the user is *changing* a constraint, acknowledge this and then paraphrase normally.
  - c. If the user typed in the proper name of an instance of the selection class, handle this specially.
  - d. If the user just added an unrecognized phrase, then indicate how it will be folded in as search. If appropriate, the input may be dispatched to a search service.
  - e. If the user is just *adding* a normal constraint, then output “OK”, and paraphrase normally.
7. To explain results, use the same approach for paraphrase. However, when the results are surprising or unexpected, then explain the results using knowledge about the data and service. Also, when the query is over- or underconstrained, prompt for more input.

### ***Grammar for Constructing Complex Noun Phrases***

**[0443]** In one embodiment, when paraphrasing 734 a constrained selection task query, the foundation is a complex noun phrase around the selection class that refers to the current constraints. Each constraint has a grammatical position, based on its type. For example, in one embodiment, assistant 1002 may construct a paraphrase such as:

*recommended romantic Italian restaurants near Menlo Park  
with open tables for 2 that serve osso buco and are described as “quiet”*

A grammar to construct this is

<paraphraseNounClause> ::= <binaryConstraint> <searchQualifier> <categoryConstraint> <itemNoun> <locationConstraint> <availabilityConstraint> <adjectivalClauses>

<binaryConstraint> ::= single adjective that indicates the presence or absence of a BinaryConstraint (e.g., recommended (best), affordable (cheap))  
*It is possible to list more than one in the same query.*

<searchQualifier> ::= a word or words that match the ontology for a qualifier of the selection class, which would be passed into a search engine service. (e.g., romantic restaurants, funny movies).  
*Use when ConstraintType= SearchQualifier.*

<categoryConstraint> ::= an adjective that identifies the genre, cuisine, or category of the selection class (e.g., Chinese restaurant or R-rated file).  
It is the last prefix adjective because it is the most intrinsic. *Use for features of type CategoryConstraint and Grammatical-Role=AdjectiveBeforeNoun.*

<itemNoun> ::= <namedEntityPhrase> | <selectionClass> | <selectionClassSubType>  
*find the most specific way to display the noun. NamedEntity < SubType < Class*

<selectionClass > ::= a noun that is the generic name for the selection class (e.g., restaurant, movie, place)

<selectionClassSubType> ::= a noun phrase that is the subtype of the selection class if it is known (e.g., diner, museum, store, bar for the selection

class local business). Use for features in which *ConstraintType* = *CategoryConstraint* and *GrammaticalRole* = *AdjectiveBeforeNoun*.

<namedEntityPhrase> ::= <entityName> |  
 "the" (<selectionClass> | <selectionClassSubType>)

<entityName> ::= the proper name of an instance of the selection class (e.g.,  
 "Il Fornaio" "Animal House" "Harry's Bar")

<locationConstraint> ::= <locationPreposition> <locationName>

<locationPreposition> ::= "in", "near", "at", and the like

<locationName> ::= city, street address, landmark, or something for GPS like  
 "your current location"

<availabilityConstraint> ::= the availability constraint expressed as a prepositional phrase that comes after the noun (e.g., "with open tables", "with seats available", "available online"). It comes right after the noun to give it salience.

<adjectivalClauses> ::= <modiferVerbPhrase> | "that"  
 <modiferVerbPhrase> "and" <modiferVerbPhrase>

<modiferVerbPhrase> := a verb phrase that expresses a search-keyword style constraint on the selection class (e.g., restaurants that "are described as quiet", "serve meat after 11", "match 'tragically hip' in reviews"; movies that "contain violence", "star Billy Bob Thornton"). Include all constraints in the parse whose *GrammaticalRole* = *ThatClauseModifer*, using the "that...and" variant if there are more than one. Use the *DisplayTemplatePlural* to generate the "that" clauses, putting the *Guessed-*

Qualifier last. If there is only one such constraint, use the Display-TemplateCompact variant.

**[0444]** Table 2 provides some examples of paraphrases that may be provided in response to the first input for a task, according to one embodiment.

Input	Initial Paraphrase
tie house	Sorry, I don't understand "tie house". I know about <u>restaurants</u> , <u>hotels</u> , and other <u>local businesses</u> , <u>flights</u> , <u>weather</u> , and <u>buying things</u> online. What are you looking for, and where?
palo alto	I can help you find restaurants, businesses, events, and things to do in Palo Alto. What are you looking for?
food	Looking for a place to eat? Where? (examples)
Italian food	I can tell you about <u>Italian</u> restaurants in your area. <u>Where</u> would you like to eat?
burrito	I can help you find places that serve burritos in your area. <u>Where</u> would you like to eat?
best mexican food	I can help you find good <u>Mexican</u> restaurants in your area. Where are you?
restaurants palo alto	Looking for restaurants near Palo Alto.
Italian palo alto	Looking for <u>Italian</u> restaurants near <u>Palo Alto</u> .
thai food in menlo park	Looking for <u>Thai</u> restaurants near <u>Menlo Park</u>
indonesian food in menlo park	Looking for <u>Indonesian</u> restaurants near <u>Menlo Park</u>
best mexican food in Palo Alto	Looking for <u>recommended Mexican</u> restaurants near <u>Palo Alto</u> .
fast food menlo park	Looking for fast food restaurants near Menlo Park
healthy food in menlo park	Looking for places near <u>Menlo Park</u> that serve <u>healthy food</u> .
dive bar in menlo park	Looking for dive <u>bars</u> near <u>Menlo Park</u> .
pool room in menlo park	Looking for pool rooms near <u>Menlo Park</u> .
hookah room in menlo park	Looking for places near <u>Menlo Park</u> described as "hookah room".
spicy food in sf	Looking for places near <u>Menlo Park</u> that serve <u>spicy food</u> .
burgers in Menlo park	Looking for places near <u>Menlo Park</u> that serve <u>burgers</u> .
belly dancing place in sf	Looking for places near <u>San Francisco</u> described as "belly dancing".
belly dancing place in menlo park	Looking for places near <u>Menlo Park</u> described as "belly dancing".
juke joint in sf	Looking for joints near <u>San Francisco</u> described as "juke".
tie house Menlo park	Looking for places near <u>Menlo Park</u> described as "tie house".
thai house palo alto	Looking up <u>Thai House</u> in <u>Palo Alto</u>
il fornaio menlo park	Looking up <u>Il Fornaio</u> in <u>Palo Alto</u>
il fornao in Menlo park	Looking for places near <u>Palo Alto</u> described as "il fornao".
cliff house in Menlo park	Looking up <u>Cliff House</u> in <u>Palo Alto</u>

romantic restaurant in palo alto	Looking for <u>romantic</u> restaurants in <u>Palo Alto</u>
romantic restaurant in palo alto	Looking for <u>romantic</u> restaurants in <u>Palo Alto</u>
quiet romantic restaurant in palo alto	Looking for <u>romantic</u> restaurants in <u>Palo Alto</u> described as "quiet"
quiet romantic restaurant in palo alto	Looking for <u>romantic</u> restaurants in <u>Palo Alto</u> described as "quiet"
tragically hip restaurant in palo alto	Looking for restaurants in <u>Palo Alto</u> described as "tragically hip"
tragically hip restaurant in palo alto	Looking for restaurants in <u>Palo Alto</u> described as "tragically hip"
table for two tonight in palo alto	Checking availability for <u>tonight</u> at restaurants near <u>Palo Alto</u> .
table for two italian food tonight in palo alto	Checking availability for <u>tonight</u> at <u>Italian</u> restaurants near <u>Palo Alto</u> .
il fornaio palo alto 6pm for 2	Checking availability for tables <u>tonight</u> at <u>Il Fornaio</u> in <u>Palo Alto</u> .
table for 2 at thai house in PA	Checking availability for tables <u>tonight</u> at <u>Thai House</u> in <u>Palo Alto</u> .
pizza delivery in menlo park	
I want the best quiet romantic italian restaurant for osso buco in or near menlo park	OK, looking for <u>recommended romantic italian</u> restaurants near <u>Menlo Park</u> that serve <u>osso buco</u> and are described as "quiet".
Book me a table for 2 at the best quiet romantic italian restaurant for osso buco in or near menlo park	OK, looking for <u>recommended romantic italian</u> restaurants near <u>Menlo Park</u> with <u>open tables for 2</u> that serve <u>osso buco</u> and are described as "quiet".

Table 2: Paraphrases in response to first input

***Refining a query about places to eat***

**[0445]** Table 3 provides some examples of paraphrases in response to a situation where user's intent to find a place to eat is known, but they have not selected a particular place to eat. They are facing a list of restaurants, and they provide refinements.

Refinements	
menlo park (was unknown)	Thanks, now looking for restaurants in <u>Menlo Park</u> .

cheapest	OK, looking for <u>affordable</u> restaurants near <u>Menlo Park</u> .
chinese (was italian)	OK, changing cuisine to Chinese. Looking for <u>Chinese</u> restaurants near <u>Menlo Park</u> .
pizza (adding food item)	OK, looking for <u>Italian</u> restaurants near <u>Menlo Park</u> that serve <u>pizza</u> .
san francisco (was menlo park)	OK, changing location to San Francisco. Looking for <u>Italian</u> restaurants near <u>San Francisco</u> that serve <u>pizza</u> .
tragically hip	OK, I'll search reviews for "tragically hip".
quiet romantic	OK, looking for <u>romantic</u> restaurants in <u>Palo Alto</u> described as "quiet"
cliff house	Cliff House sounds familiar. I'll look it up in Palo Alto.

Table 3: Paraphrases in response to refinements

**[0446]** Table 4 provides some examples of results summaries that are provided once results are obtained.

Input	# Results	Results Summary
tie house	N/A	N/A (no call to services)
palo alto	N/A	N/A (no call to services)
food	N/A	N/A (no call to services)
Italian food	N/A	N/A (no call to services)
burrito	N/A	N/A (no call to services)
best mexican food	N/A	N/A (no call to services)
restaurants palo alto	many	Here are some <u>recommended</u> restaurants near <u>Palo Alto</u> . Do you prefer any particular <u>food type</u> ? Would you like a <u>reservation</u> ?
Italian palo alto	some	Here are some <u>Italian</u> restaurants near <u>Palo Alto</u> . To reserve a table, click on available times.
thai food in menlo park	some	Here are some <u>Thai</u> restaurants near <u>Menlo Park</u> . To reserve a table, click on available times.
indonesian food in menlo park	0	Sorry, I can't find any <u>Indonesian</u> restaurants near <u>Menlo Park</u> . You could try other <u>cuisines</u> or <u>locations</u> .
best mexican food in Palo Alto	some	Here are some <u>recommended Mexican</u> restaurants near <u>Palo Alto</u> .
fast food menlo park	some	OK, here are some <u>fast food</u> restaurants near <u>Menlo Park</u> .
healthy food in menlo park	some	Here are some places near Menlo Park that might serve healthy food, based on reviews.
dive bar in menlo park	some	Here are some bars near <u>Menlo Park</u> . I don't see anything specific to "dive bar". Are there other ways of saying it?



pool room in menlo park	some	Here are some places in <u>Menlo Park</u> that are described as pool rooms. You can add other words to describe what you want.
hookah room in menlo park	0	I can't find places <u>Menlo Park</u> matching "hookah room". Interested in <u>restaurants</u> , <u>hotels</u> , or <u>local businesses</u> ?
spicy food in sf	weak match	Here are some places to eat in <u>San Francisco</u> . I don't know which serve <u>spicy food</u> . Could it go by another name?
burgers in Menlo park	some	You might find <u>burgers</u> at these <u>places to eat</u> near <u>Menlo Park</u> .
belly dancing place in sf	some	Here are some places in <u>Menlo Park</u> that are described as "belly dancing". You can add other words to describe what you want.
belly dancing place in menlo park	0	I can help you find <u>restaurants</u> , <u>businesses</u> , <u>events</u> , and <u>things to do</u> in <u>San Francisco</u> . What are some other words for "belly dancing place"?
juke joint in sf	0	I can help you find <u>restaurants</u> , <u>businesses</u> , <u>events</u> , and <u>things to do</u> in <u>San Francisco</u> . What are some other words for "juke joint"?
tie house Menlo park	0	Sorry, I don't know about "tie house" in <u>Menlo Park</u> . Any other names for it?
thai house palo alto	1	Got it: Thai House <u>restaurant</u> in <u>Palo Alto, CA</u> . Want to reserve a table? When and for how many?
il fornaio menlo park	weak match	There is a Il Fornaio restaurant in Palo Alto, which is near Menlo Park.
il fornao in Menlo park	spell match	Did you mean <u>Il Fornaio</u> in <u>Palo Alto</u> ? If not, try different words.
cliff house in Menlo park	0	I couldn't find <u>Cliff House</u> in <u>Palo Alto</u> . Could it go by a different name or be in a different city?
romantic restaurant in palo alto	some	Here are some restaurants near <u>Palo Alto</u> that are described in reviews as romantic.
romantic restaurant in palo alto	0	Here are restaurants near <u>Palo Alto</u> . Searching reviews did not find any described as romantic. Any other preferences?
quiet romantic restaurant in palo alto	some	Here are some restaurants near <u>Palo Alto</u> that match "quiet romantic" in reviews.
quiet romantic restaurant in palo alto	0	Here are some restaurants near <u>Palo Alto</u> . Searching reviews did not find any matching "quiet romantic". Any other preferences?
tragically hip restaurant in palo alto	some	Here are some restaurants near <u>Palo Alto</u> that match "tragically hip" in reviews.

tragically hip restaurant in palo alto	0	Here are some restaurants near <u>Palo Alto</u> . Searching reviews did not find any matching "tragically hip". Any other preferences?
table for two tonight in palo alto	some	Here are restaurants with open tables from <u>6pm to 8pm tonight</u> for a <u>party of two</u> in <u>Palo Alto, CA</u> .
table for two italian food tonight in palo alto	some	Here are restaurants with open tables from <u>6pm to 8pm tonight</u> for a <u>party of two</u> in <u>Palo Alto, CA</u> .
il fornaio palo alto 6pm for 2	1	Here are table options at <u>Il Fornaio</u> restaurant in <u>Palo Alto, CA</u> at <u>6pm today</u> for a <u>party of 2</u> .
table for 2 at thai house in PA	1	Here is the information for <u>Thai House</u> in <u>Palo Alto, CA</u> . You can call them at the phone number listed.
pizza delivery in menlo park		Here are places that serve pizza in menlo park. I do not have delivery options at this time. Click on restaurant phone numbers to call for delivery.
I want the best quiet romantic italian restaurant for osso buco in or near menlo park	weak match, sorted by availability	Here are the best matches for <u>recommended romantic italian</u> restaurants near <u>Menlo Park</u> that serve <u>osso buco</u> and are described as "quiet". Click on available times to reserve a table.
Book me a table for 2 at the best quiet romantic italian restaurant for osso buco in or near menlo park	weak match, sorted by availability	Here are the best matches for <u>recommended romantic italian</u> restaurants near <u>Menlo Park</u> with <u>open tables for 2</u> that serve <u>osso buco</u> and are described as "quiet". Click on available times to reserve a table.
<b>refinements</b>		
menlo park (was unknown)	some	Here are some <u>recommended</u> restaurants near <u>Menlo Park</u> . Do you prefer any particular food type?
cheapest	some	I found 4 <u>affordable</u> restaurants near <u>Menlo Park</u> .
chinese (was italian)		I found 4 <u>Chinese</u> restaurants near <u>Menlo Park</u> .
pizza (adding food item)	some	I found 4 <u>Italian</u> restaurants near <u>Menlo Park</u> that serve <u>pizza</u> .
san francisco (was menlo park)	some	I found 4 <u>Italian</u> restaurants near <u>San Francisco</u> .
tragically hip	some	I found 4 restaurants near <u>Palo Alto</u> that match "tragically hip" in reviews.
quiet romantic	some	Here are some restaurants near <u>Palo Alto</u> that match "quiet romantic" in reviews.

cliff house	0	I couldn't find <u>Cliff House</u> in <u>Palo Alto</u> . Could it go by a different name or be in a different city?
-------------	---	---------------------------------------------------------------------------------------------------------------------

Table 4: Results Summaries

**[0447]** Table 5 provides some examples of prompts that are provided when users click on active links.

***Prompts when users click on active links***

Anchor Text	Prompt Text	Notes
Location, where	Enter a location: a city, zip code, or "near" followed by the name of a place.	This prompt might be used when the user has not specified a location yet.
Palo Alto	Enter a location such as a city, neighborhood, street address, or "near" followed by a landmark.	This prompt might be used when the user is changing locations.
food type	Enter a food category such as Chinese or Pizza.	Merge food type and cuisine can be merged
Italian	You can try other food categories such as Chinese, or a favorite food item such as steak.	User already said Italian. Assistant 1002 is helping the user explore alternatives. If it is a food item, it dominates over cuisine.
reservation	Enter the day and time to reserve a table, such as "tomorrow at 8".	Prompting for a reservation
healthy food	You can also enter menu items or cuisines	Known food type
spicy food	You can also enter menu items or cuisines	Unknown food type
restaurants	What kind of restaurant? (e.g., Chinese, Pizza)	Clicking on the restaurants link should insert the word "restaurant" on the end of the text input.
businesses	You can find local florists, ATMs, doctors, drug stores, and the like What kind of business are you looking for?	Clicking on the businesses link should add to the machine readable tag that this is a local search
events	You can discover upcoming concerts, shows, and the like What interests you?	
things to do	Music, art, theater, sports, and the like What kind of thing would you like to do in this area?	

hotels	I can help you find an available hotel room. Any preferences for amenities or location?	
weather	Enter a city, and I'll tell you what the weather is like there.	If location is known, just show the weather data
buying things	I can help you find music, movies, books, electronics, toys, and more -- and buy it from Amazon. What are you looking for?	

Table 5: Prompts when users click on active links

### ***Suggesting Possible Responses in a Dialog***

**[0448]** In one embodiment, assistant 1002 provides contextual suggestions. Suggestions a way for assistant 1002 to offer the user options to move forward from his or her current situation in the dialog. The set of suggestions offered by assistant 1002 depends on context, and the number of suggestions offered may depend on the medium and form factor. For example, in one embodiment, the most salient suggestions may be offered in line in the dialog, an extended list of suggestions (“more”) may be offered in a scrollable menu, and even more suggestions are reachable by typing a few characters and picking from autocomplete options. One skilled in the art will recognize that other mechanisms may be used for providing suggestions.

**[0449]** In various embodiments, different types of suggestions may be provided. Examples of suggestion types include:

- options to refine a query, including adding or removing or changing constraint values;
- options to repair or recover from bad situations, such as “not what I mean” or “start over” or “search the web”;
- options to disambiguate among;
- interpretations of speech;
- interpretations of text, including spell correction and semantic ambiguity;

- context-specific commands, such as “show these on a map” or “send directions to my date” or “explain these results”;
- suggested cross-selling offers, such as next steps in meal or event planning scenarios;
- options to reuse previous commands, or parts of them.

**[0450]** In various embodiments, the context that determines the most relevant suggestions may be derived from, for example:

- dialog state
- user state, including, for example:
  - static properties (name, home address, etc)
  - dynamic properties (location, time, network speed)
- interaction history, including, for example:
  - query history
  - results history
  - the text that has been entered so far into autocomplete.

**[0451]** In various embodiments, suggestions may be generated by any mechanism, such as for example:

- paraphrasing a domain, task, or constraint based on the ontology model;
- prompting in autocomplete based on the current domain and constraints;
- paraphrasing ambiguous alternative interpretations;
- alternative interpretations of speech-to-text;
- hand authoring, based on special dialog conditions.

**[0452]** According to one embodiment, suggestions are generated as operations on commands in some state of completion. Commands are explicit, canonical representations of requests, including assumptions and inferences, based on attempted interpretations on user input. In situations where the user input is incomplete or ambiguous, suggestions are an attempt to help the user adjust the input to clarify the command.

**[0453]** In one embodiment, each command is an imperative sentence having some combination of a

- command verb (imperative such as “find” or “where is”);
- domain (selection class such as “restaurants”);
- constraint(s) such as location=Palo Alto and cuisine=Italian.

**[0454]** These parts of a command (verb, domain, constraints) correspond to nodes in the ontology.

**[0455]** A suggestion, then, may be thought of as operations on a command, such as setting it, changing it, or declaring that it is relevant or not relevant.

Examples include:

- setting a command verb or domain (“find restaurants” )
- changing a command verb (“book it”, “map it”, “save it”)
- changing a domain (“looking for a restaurant, not a local business”)
- stating that a constraint is relevant (“try refining by cuisine”)
- choosing a value for a constraint (“Italian”, “French”, and the like)
- choosing a constraint and value together (“near here”, “tables for 2”)
- stating that a constraint value is wrong (“not that Boston”)
- stating that a constraint is not relevant (“ignore the expense”)
- stating the intent to change a constraint value (“try a different location”)
- changing a constraint value (“Italian, not Chinese”)
- adding to a constraint value (“and with a pool, too”)
- snapping a value to grid (“Los Angeles, not los angeles”)
- initiating a new command, reusing context ([after movies] “find nearby restaurants”, “send directions to my friend”)
- initiating a command that is “meta” to context (“explain these results”)
- initiating a new command, resetting or ignoring context (“start over”, “help with speech”)

**[0456]** A suggestion may also involve some combination of the above. For example:

- “the movie Milk not [restaurants serving] the food item milk”
- “restaurants serving pizza, not just pizza joints”
- “The place called Costco in Mountain View, I don’t care whether you think it is a restaurant or local business”
- “Chinese in mountain view” [a recent query]

**[0457]** In one embodiment, assistant 1002 includes a general mechanism to maintain a list of suggestions, ordered by relevance. The format in which a suggestion is offered may differ depending on current context, mode, and form factor of the device.

**[0458]** In one embodiment, assistant 1002 determines which constraints to modify by considering any or all of the following factors:

- Consider whether the constraint has a value;
- Consider whether the constraint was inferred or explicitly stated;
- Consider its salience (suggestionIndex).

**[0459]** In one embodiment, assistant 1002 determines an output format for the suggestion. Examples of output formats include:

- change domain:
  - if autocomplete option “find restaurants”, then “try something different”
  - else [was inferred] “not looking for restaurants”
- change name constraint:
  - if name was inferred, offer alternative ambiguous interpretation”
  - stuff into autocomplete the entity names from current results
  - *different name*
  - consider that it wasn’t a name lookup (remove constraint) - maybe offer category in place of it

- “not named”
- “not in Berkeley”
- “some other day”
- not that sense of (use ambiguity alternatives)
- inferred date: “any day, I don’t need a reservation”

**[0460]** In one embodiment, assistant 1002 attempts to resolve ambiguities via suggestions. For example, if the set of current interpretations of user intent is too ambiguous 310, then suggestions are one way to prompt for more information 322. In one embodiment, for constrained selection tasks, assistant 1002 factors out common constraints among ambiguous interpretations of intent 290 and presents the differences among them to the user. For example, if the user input includes the word “café” and this word could match the name of a restaurant or the type of restaurant, then assistant 102 can ask “did you mean restaurants named ‘café’ or ‘café restaurants’?”

**[0461]** In one embodiment, assistant 1002 infers constraints under certain situations. That is, for constrained selection tasks, not all constraints need be mentioned explicitly in the user input; some can be inferred from other information available in active ontology 1050, short term memory 1052, and/or other sources of information available to assistant 1002. For example:

- Inferring domain or location
- Default assumption, like location
- Weakly matched constraint (fuzzy, low salience location, etc)
- Ambiguous criteria (match to constraint value without prefix (name vs. category, often ambiguous)

**[0462]** In cases where the assistant 1002 infers constraint values, it may also offer these assumptions as suggestions for the user to overrule. For example, it might tell the user “I assumed you meant around here. Would you like to look at a different location?”

**[0463]** The present invention has been described in particular detail with respect to possible embodiments. Those of skill in the art will appreciate that



the invention may be practiced in other embodiments. First, the particular naming of the components, capitalization of terms, the attributes, data structures, or any other programming or structural aspect is not mandatory or significant, and the mechanisms that implement the invention or its features may have different names, formats, or protocols. Further, the system may be implemented via a combination of hardware and software, as described, or entirely in hardware elements, or entirely in software elements. Also, the particular division of functionality between the various system components described herein is merely exemplary, and not mandatory; functions performed by a single system component may instead be performed by multiple components, and functions performed by multiple components may instead be performed by a single component.

**[0464]** In various embodiments, the present invention can be implemented as a system or a method for performing the above-described techniques, either singly or in any combination. In another embodiment, the present invention can be implemented as a computer program product comprising a non-transitory computer-readable storage medium and computer program code, encoded on the medium, for causing a processor in a computing device or other electronic device to perform the above-described techniques.

**[0465]** Reference in the specification to “one embodiment” or to “an embodiment” means that a particular feature, structure, or characteristic described in connection with the embodiments is included in at least one embodiment of the invention. The appearances of the phrase “in one embodiment” in various places in the specification are not necessarily all referring to the same embodiment.

**[0466]** Some portions of the above are presented in terms of algorithms and symbolic representations of operations on data bits within a memory of a computing device. These algorithmic descriptions and representations are the means used by those skilled in the data processing arts to most effectively convey the substance of their work to others skilled in the art. An algorithm

is here, and generally, conceived to be a self-consistent sequence of steps (instructions) leading to a desired result. The steps are those requiring physical manipulations of physical quantities. Usually, though not necessarily, these quantities take the form of electrical, magnetic or optical signals capable of being stored, transferred, combined, compared and otherwise manipulated. It is convenient at times, principally for reasons of common usage, to refer to these signals as bits, values, elements, symbols, characters, terms, numbers, or the like. Furthermore, it is also convenient at times, to refer to certain arrangements of steps requiring physical manipulations of physical quantities as modules or code devices, without loss of generality.

**[0467]** It should be borne in mind, however, that all of these and similar terms are to be associated with the appropriate physical quantities and are merely convenient labels applied to these quantities. Unless specifically stated otherwise as apparent from the following discussion, it is appreciated that throughout the description, discussions utilizing terms such as “processing” or “computing” or “calculating” or “displaying” or “determining” or the like, refer to the action and processes of a computer system, or similar electronic computing module and/or device, that manipulates and transforms data represented as physical (electronic) quantities within the computer system memories or registers or other such information storage, transmission or display devices.

**[0468]** Certain aspects of the present invention include process steps and instructions described herein in the form of an algorithm. It should be noted that the process steps and instructions of the present invention can be embodied in software, firmware and/or hardware, and when embodied in software, can be downloaded to reside on and be operated from different platforms used by a variety of operating systems.

**[0469]** The present invention also relates to an apparatus for performing the operations herein. This apparatus may be specially constructed for the required purposes, or it may comprise a general-purpose computing device

selectively activated or reconfigured by a computer program stored in the computing device. Such a computer program may be stored in a computer readable storage medium, such as, but is not limited to, any type of disk including floppy disks, optical disks, CD-ROMs, magnetic-optical disks, read-only memories (ROMs), random access memories (RAMs), EPROMs, EEPROMs, magnetic or optical cards, application specific integrated circuits (ASICs), or any type of media suitable for storing electronic instructions, and each coupled to a computer system bus. Further, the computing devices referred to herein may include a single processor or may be architectures employing multiple processor designs for increased computing capability.

**[0470]** The algorithms and displays presented herein are not inherently related to any particular computing device, virtualized system, or other apparatus. Various general-purpose systems may also be used with programs in accordance with the teachings herein, or it may prove convenient to construct more specialized apparatus to perform the required method steps. The required structure for a variety of these systems will be apparent from the description provided herein. In addition, the present invention is not described with reference to any particular programming language. It will be appreciated that a variety of programming languages may be used to implement the teachings of the present invention as described herein, and any references above to specific languages are provided for disclosure of enablement and best mode of the present invention.

**[0471]** Accordingly, in various embodiments, the present invention can be implemented as software, hardware, and/or other elements for controlling a computer system, computing device, or other electronic device, or any combination or plurality thereof. Such an electronic device can include, for example, a processor, an input device (such as a keyboard, mouse, touchpad, trackpad, joystick, trackball, microphone, and/or any combination thereof), an output device (such as a screen, speaker, and/or the like), memory, long-term storage (such as magnetic storage, optical storage, and/or the like),

and/or network connectivity, according to techniques that are well known in the art. Such an electronic device may be portable or nonportable. Examples of electronic devices that may be used for implementing the invention include: a mobile phone, personal digital assistant, smartphone, kiosk, desktop computer, laptop computer, tablet computer, consumer electronic device, consumer entertainment device; music player; camera; television; set-top box; electronic gaming unit; or the like. An electronic device for implementing the present invention may use any operating system such as, for example, iOS or MacOS, available from Apple Inc. of Cupertino, California, or any other operating system that is adapted for use on the device.

**[0472]** While the invention has been described with respect to a limited number of embodiments, those skilled in the art, having benefit of the above description, will appreciate that other embodiments may be devised which do not depart from the scope of the present invention as described herein. In addition, it should be noted that the language used in the specification has been principally selected for readability and instructional purposes, and may not have been selected to delineate or circumscribe the inventive subject matter. Accordingly, the disclosure of the present invention is intended to be illustrative, but not limiting, of the scope of the invention, which is set forth in the claims.

The embodiments of the invention in which an exclusive property or privilege is claimed are defined as follows:

1. A method for launching an application on a user device using a digital assistant, comprising:

5 at an electronic device comprising a processor and memory storing instructions for execution by the processor:

providing, at the user device, a graphical user interface including an at least partially speech-based conversational interface for interacting with a user, the graphical user interface displaying at least a portion of a conversational interaction between the user and the user device;

obtaining context information associated with an interaction between the user and the user device;

receiving a speech input from the user through the conversational interface;

15 processing the speech input to determine a user intent associated with the speech input; and

upon determination that the user intent associated with the speech input is for invoking a software application installed on the user device:

invoking the software application on the user device external to the graphical user interface including the conversational interface; and

20 providing a response based on the user intent and the context information.

2. The method of claim 1, wherein obtaining the context information further comprises:

25 receiving an additional speech input through the conversational interface prior to receiving the speech input; and

processing the additional speech input to obtain the context information.

3. The method of claim 1, wherein processing the speech input to determine the user intent associated with the speech input further comprises:  
disambiguating the speech input using the context information.
4. The method of claim 1, further comprising:  
5 receiving an additional speech input from the user through the conversational interface;  
processing the additional speech input to determine an additional user intent associated with the additional speech input; and  
based on the additional user intent that has been determined:  
10 obtaining another input related to the additional user intent from the user through the conversational interface; and  
executing a task for fulfilling the additional user intent within the conversational interface.
5. The method of claim 1, further comprising:  
15 receiving an additional speech input from the user through the conversational interface;  
processing the additional speech input to determine an additional user intent associated with the additional speech input;  
upon determination that the additional user intent associated with the  
20 additional speech input is for invoking an additional software application installed on the user device:  
invoking the additional software application on the user device outside of the conversational interface.
6. The method of claim 1, wherein obtaining the context information further  
25 comprises:  
receiving non-speech input from the user prior to the speech input; and  
processing the non-speech input to obtain the context information.

7. A system, comprising:  
one or more processors;  
memory storing instructions, the instructions configured to be executed by the  
one or more processors and cause the one or more processors to perform operations  
5 comprising: at a user device comprising a processor and memory storing instructions  
for execution by the processor:  
providing, at the user device, a graphical user interface including an at  
least partially speech-based conversational interface for interacting with a  
user, the graphical user interface displaying at least a portion of a  
10 conversational interaction between the user and the user device;  
obtaining context information associated with an interaction between  
the user and the user device;  
receiving a speech input from the user through the conversational  
interface;  
15 processing the speech input to determine a user intent associated with  
the speech input; and  
upon determination that the user intent associated with the speech  
input is for invoking a software application installed on the user device:  
invoking the software application on the user device external to  
20 the graphical user interface including the conversational interface; and  
providing a response based on the user intent and the context  
information.

8. The system of claim 7, wherein obtaining the context information further  
comprises:  
25 receiving an additional speech input through the conversational interface  
prior to receiving the speech input; and  
processing the additional speech input to obtain the context information.

9. The system of claim 7, wherein processing the speech input to determine the  
user intent associated with the speech input further comprises:

disambiguating the speech input using the context information.

10. The system of claim 7, wherein the operations further comprise:  
receiving an additional speech input from the user through the conversational  
interface;

5 processing the additional speech input to determine an additional user intent  
associated with the additional speech input; and

based on the additional user intent that has been determined:

obtaining another input related to the additional user intent from the  
user through the conversational interface; and

10 executing a task for fulfilling the additional user intent within the  
conversational interface.

11. The system of claim 7, wherein the operations further comprise:  
receiving an additional speech input from the user through the conversational  
interface;

15 processing the additional speech input to determine an additional user intent  
associated with the additional speech input;

upon determination that the additional user intent associated with the  
additional speech input is for invoking an additional software application installed on  
the user device:

20 invoking the additional software application on the user device outside  
of the conversational interface.

12. The system of claim 7, wherein obtaining the context information further  
comprises:

receiving non-speech input from the user prior to the speech input; and

25 processing the non-speech input to obtain the context information.

13. A non-transitory computer readable storage medium storing one or more  
programs, the one or more programs comprising instructions, which when executed  
by a user device, cause the device to:



provide, at the user device, a graphical user interface including an at least partially speech-based conversational interface for interacting with a user, the graphical user interface displaying at least a portion of a conversational interaction between the user and the user device, the graphical user interface displaying at least a portion of a conversational interaction between the user and the user device;

obtain context information associated with an interaction between the user and the user device;

receive a speech input from the user through the conversational interface;

process the speech input to determine a user intent associated with the speech input; and upon determination that the user intent associated with the speech input is for invoking a software application installed on the user device:

invoke the software application on the user device external to the graphical user interface including the conversational interface; and

provide a response based on the user intent and the context information.

14. The computer readable storage medium of claim 13, wherein the instructions further cause the device to:

receive an additional speech input through the conversational interface prior to receiving the speech input; and

process the additional speech input to obtain the context information.

15. The computer readable storage medium of claim 13, wherein processing the speech input to determine the user intent associated with the speech input further comprises:

disambiguating the speech input using the context information.

16. The computer readable storage medium of claim 13, wherein the instructions further cause the device to:

receive an additional speech input from the user through the conversational interface;

process the additional speech input to determine an additional user intent associated with the additional speech input; and

based on the additional user intent that has been determined:

5 obtain another input related to the additional user intent from the user through the conversational interface; and  
execute a task for fulfilling the additional user intent within the conversational interface.

17. The computer readable storage medium of claim 13, wherein the instructions further cause the device to:

10 receive an additional speech input from the user through the conversational interface;

process the additional speech input to determine an additional user intent associated with the additional speech input;

15 upon determination that the additional user intent associated with the additional speech input is for invoking an additional software application installed on the user device:

invoke the additional software application on the user device outside of the conversational interface.

18. The computer readable storage medium of claim 13, wherein obtaining the context information further comprises:

receiving non-speech input from the user prior to the speech input; and processing the non-speech input to obtain the context information.

19. The method of claim 1, wherein the speech input comprises a command to invoke the software application installed on the user device.

25 20. The system of claim 7, wherein the speech input comprises a command to invoke the software application installed on the user device.

21. The computer readable storage medium of claim 13, wherein the speech input comprises a command to invoke the software application installed on the user device.
22. The method of claim 1, wherein displaying at least a portion of the conversational interaction includes displaying a paraphrase of user input.
- 5 23. The system of claim 7, wherein displaying at least a portion of the conversational interaction includes displaying a paraphrase of user input.
24. The computer readable storage medium of claim 13, wherein displaying at least a portion of the conversational interaction includes displaying a paraphrase of user input.

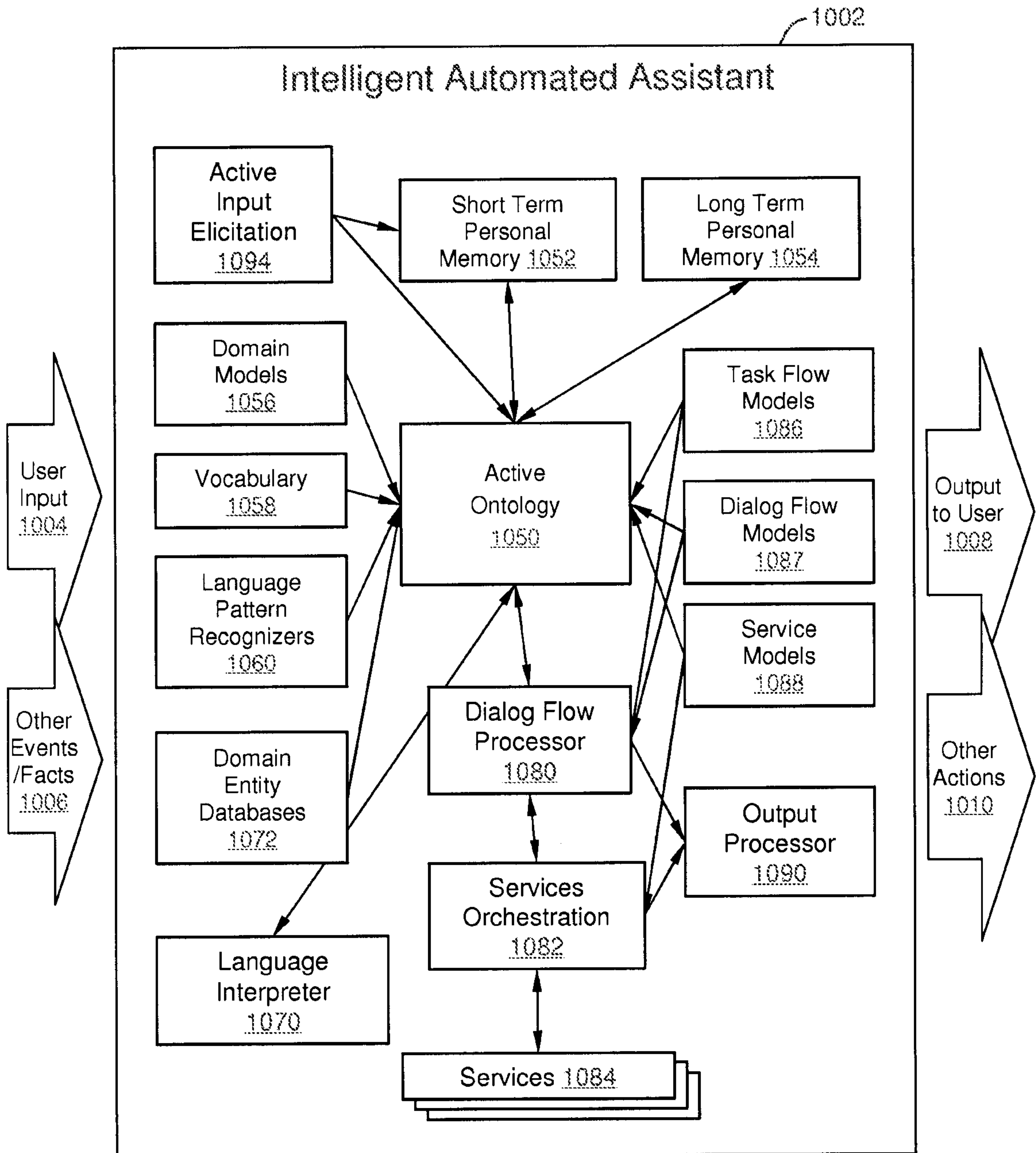

FIG. 1



FIG. 2

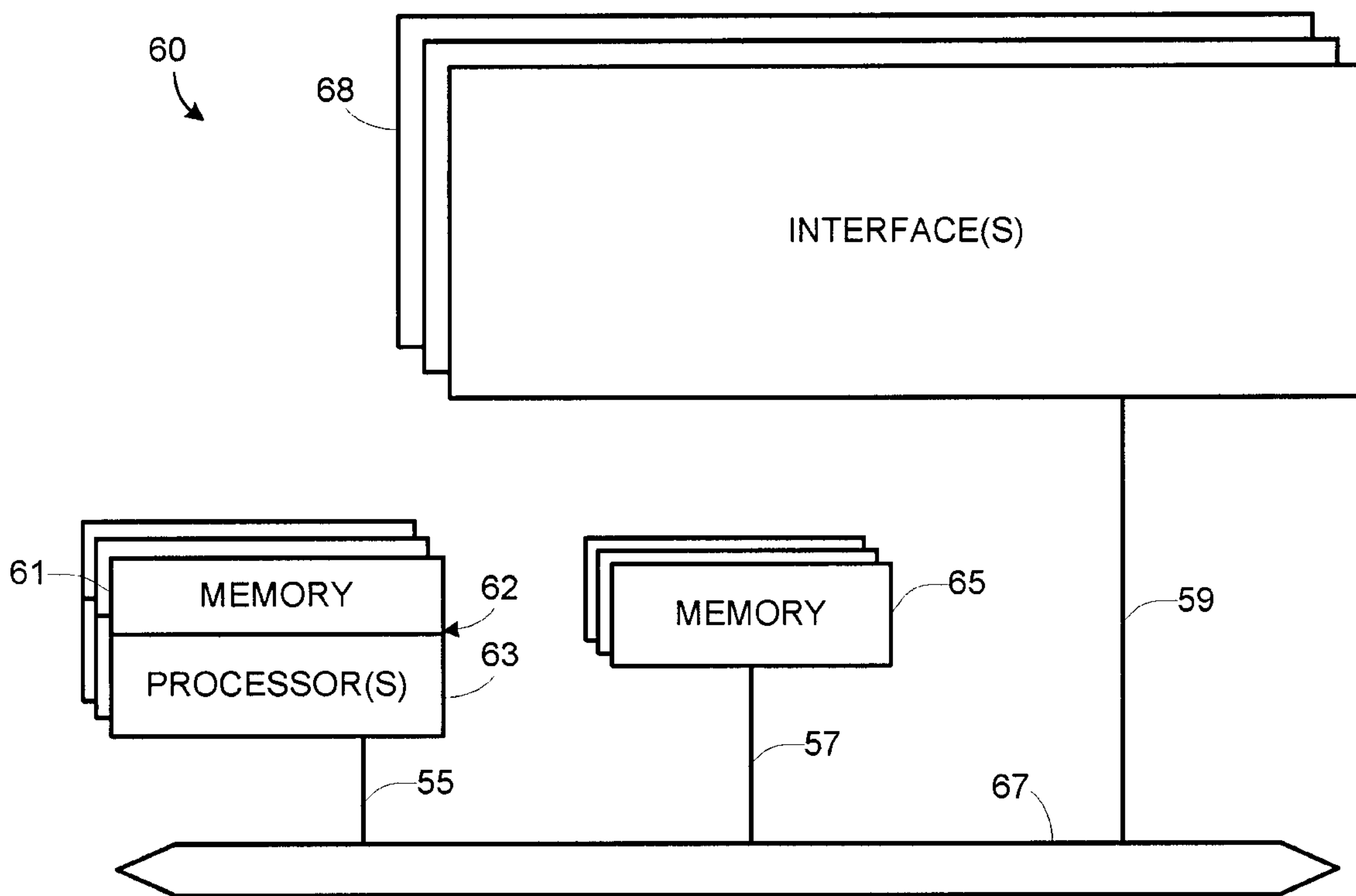
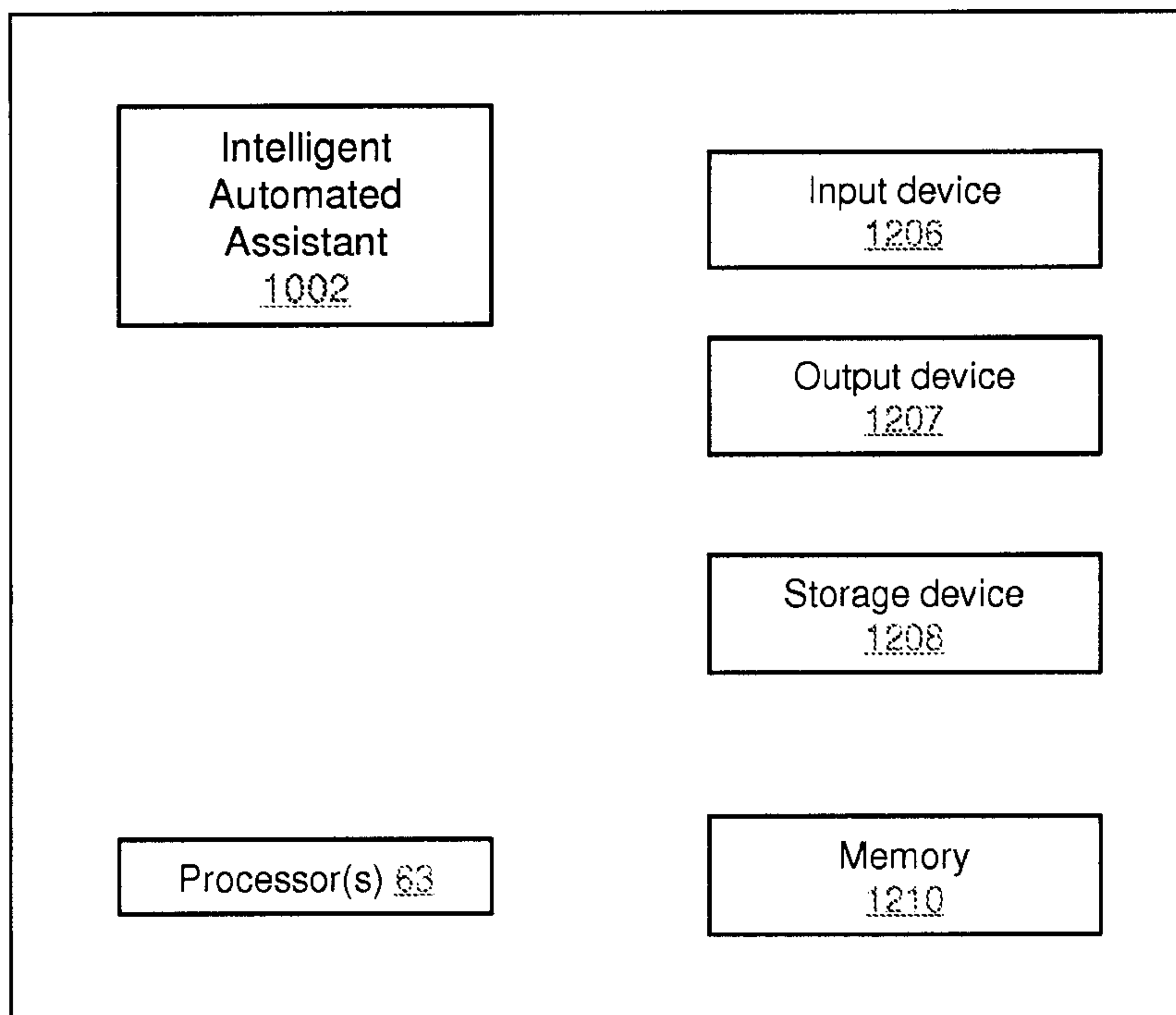

FIG. 3

60 ↘



**FIG. 4**

5 / 47

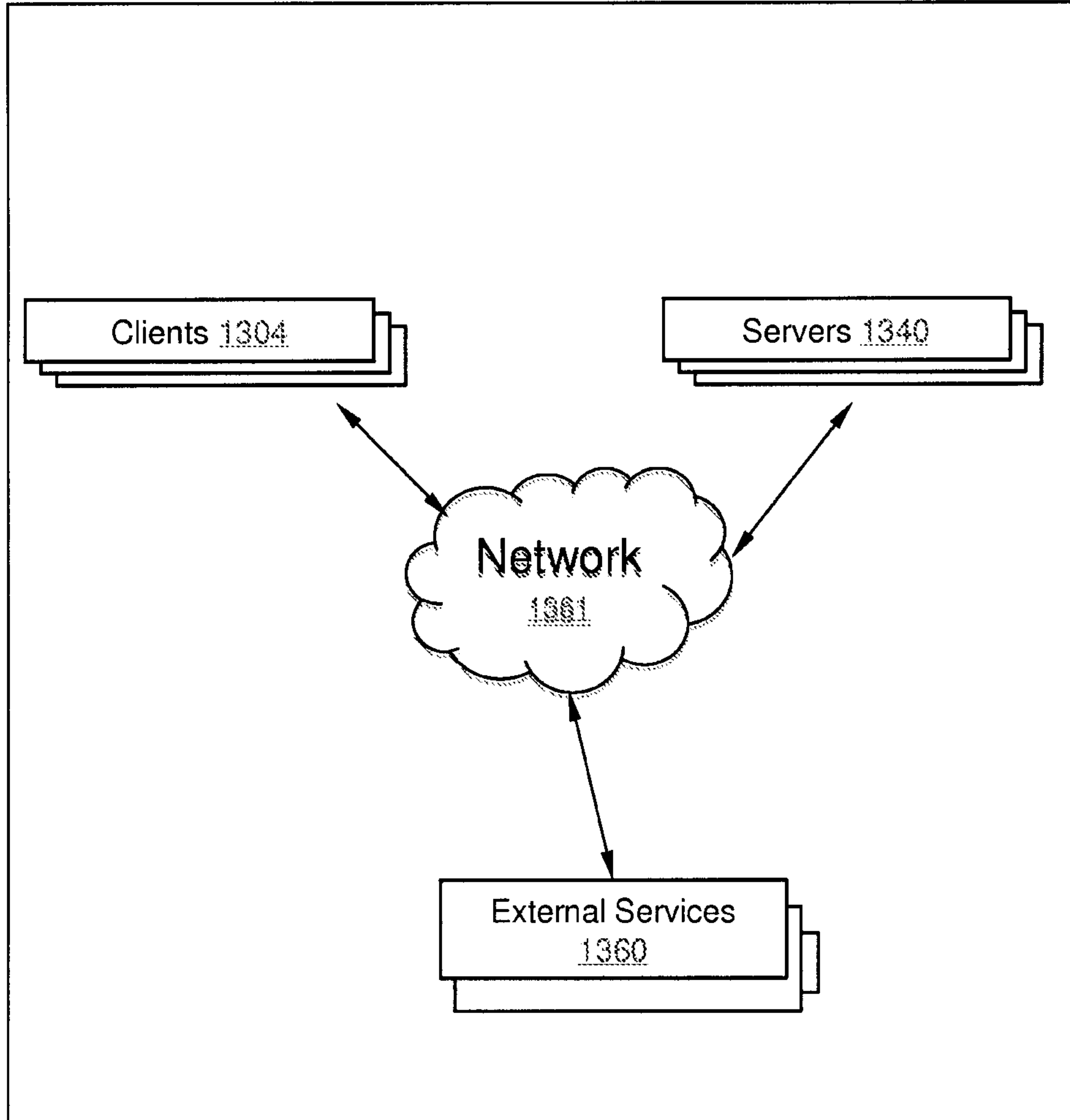

FIG. 5



6 / 47

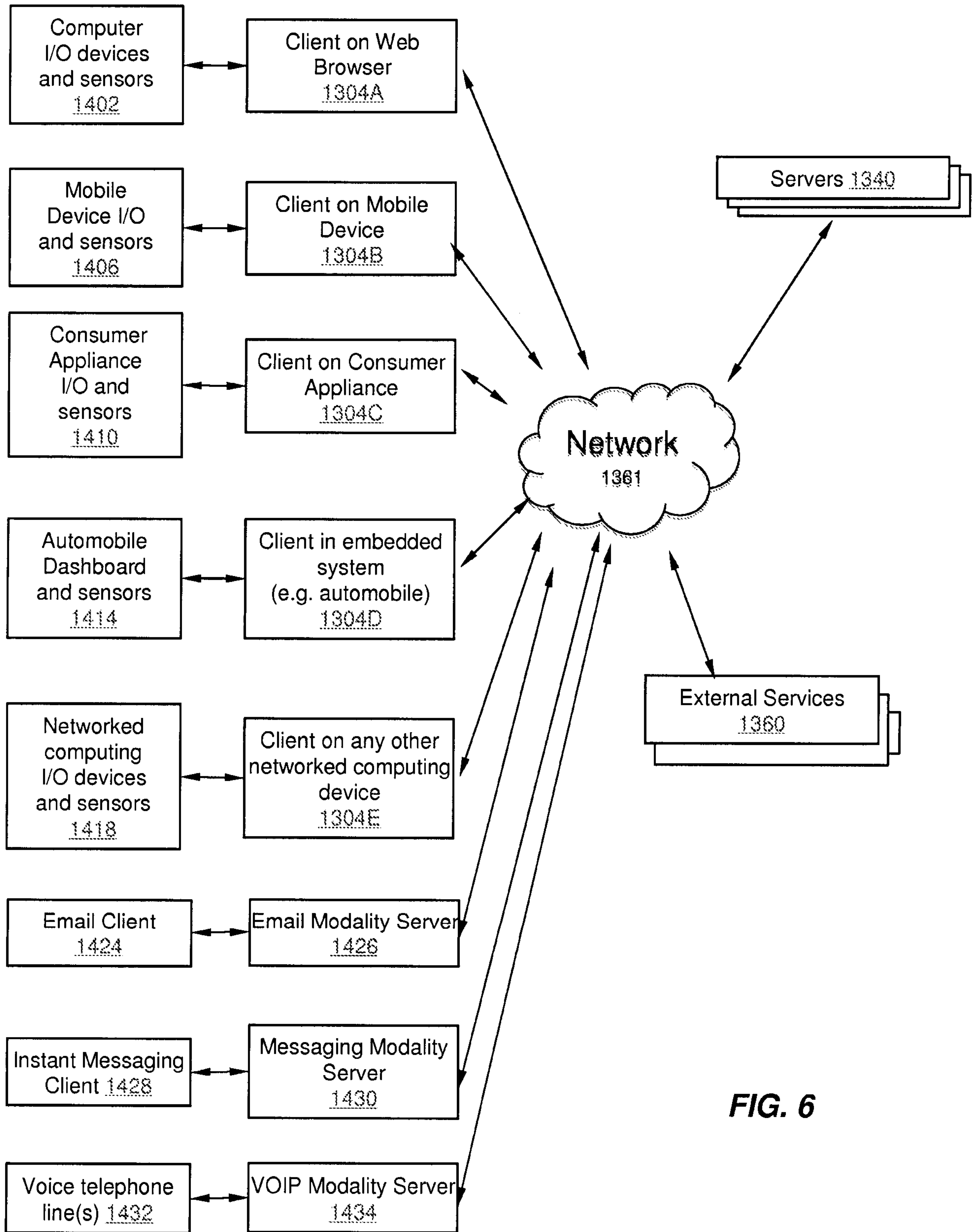

FIG. 6

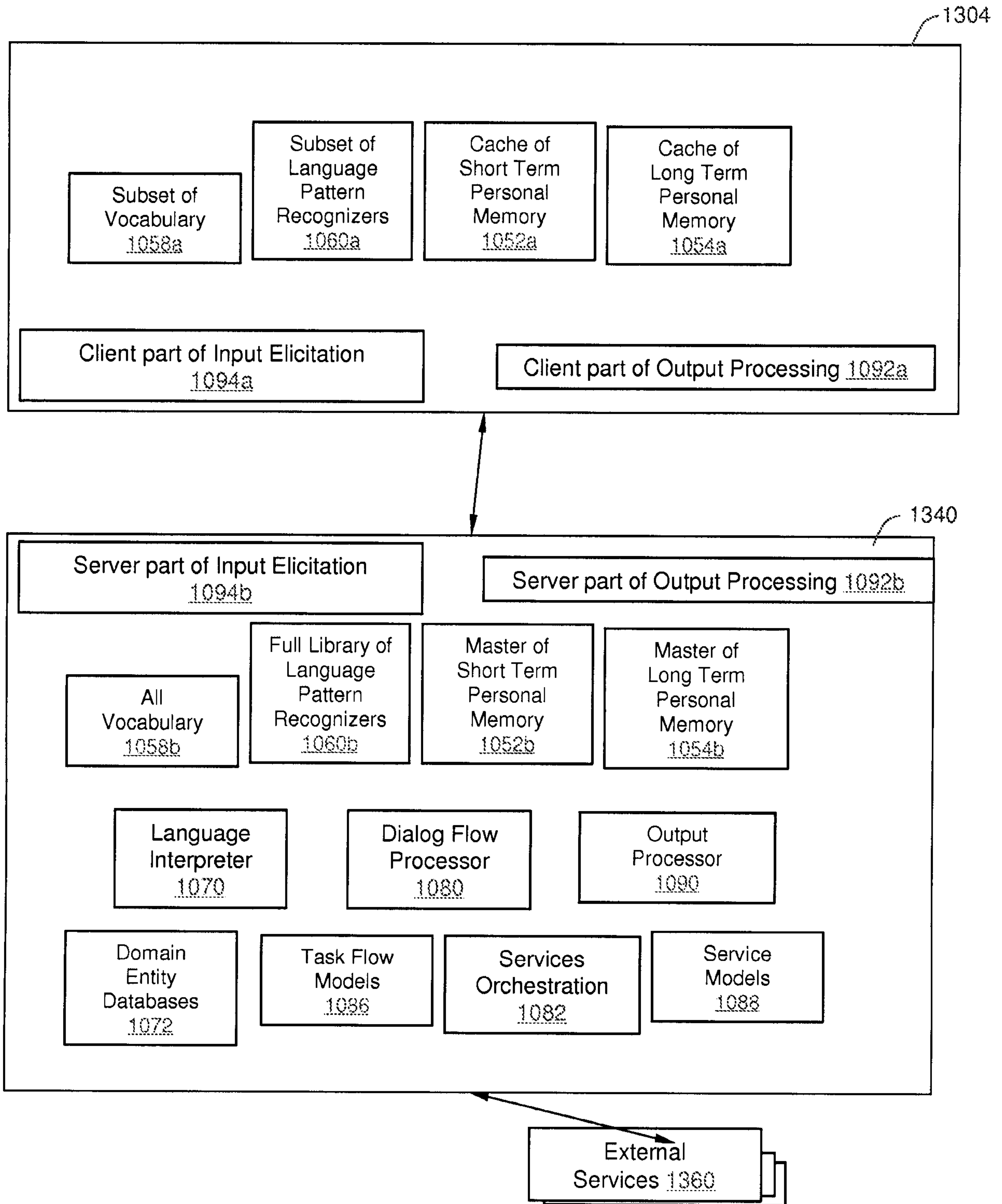

FIG. 7

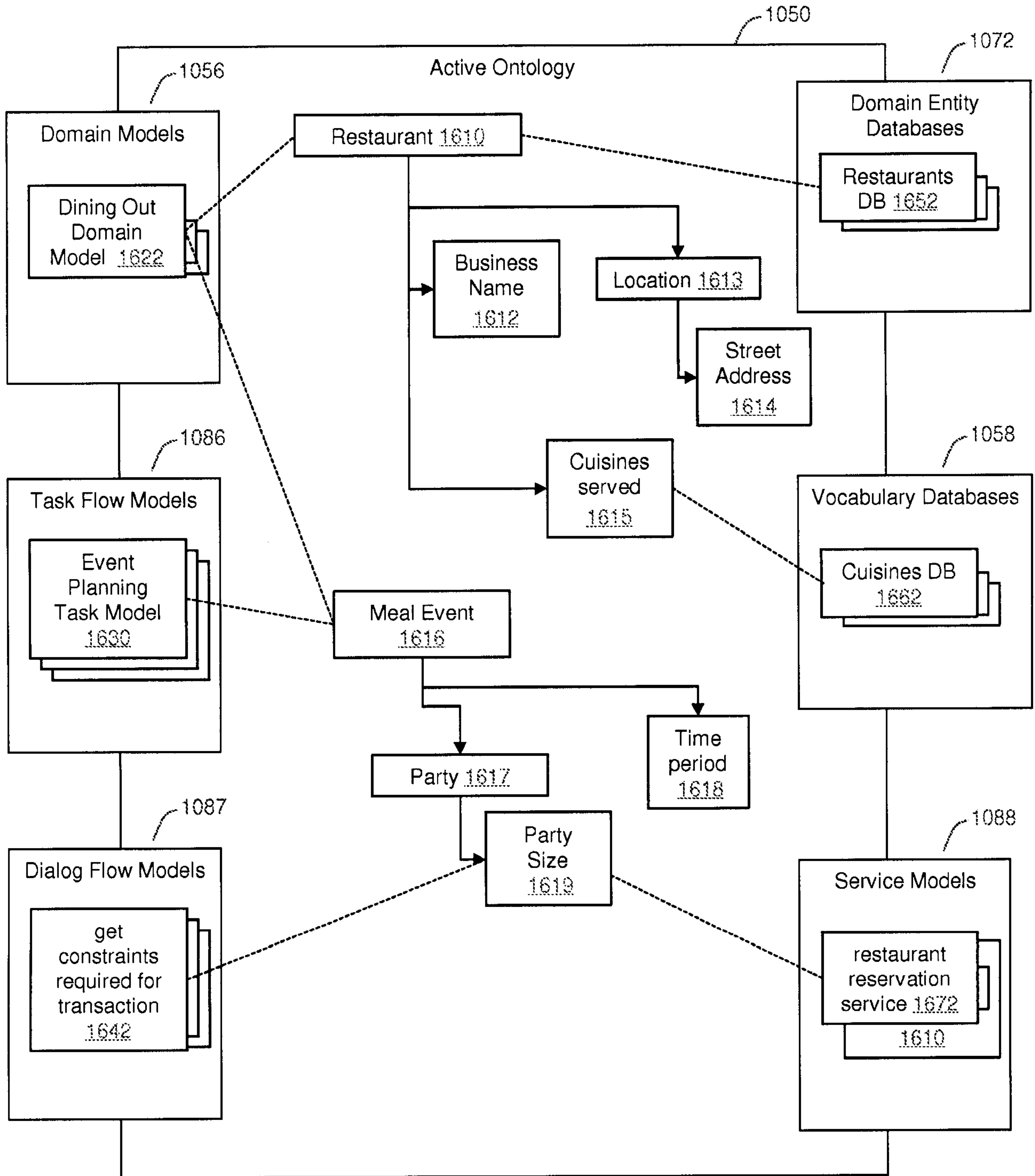

FIG. 8

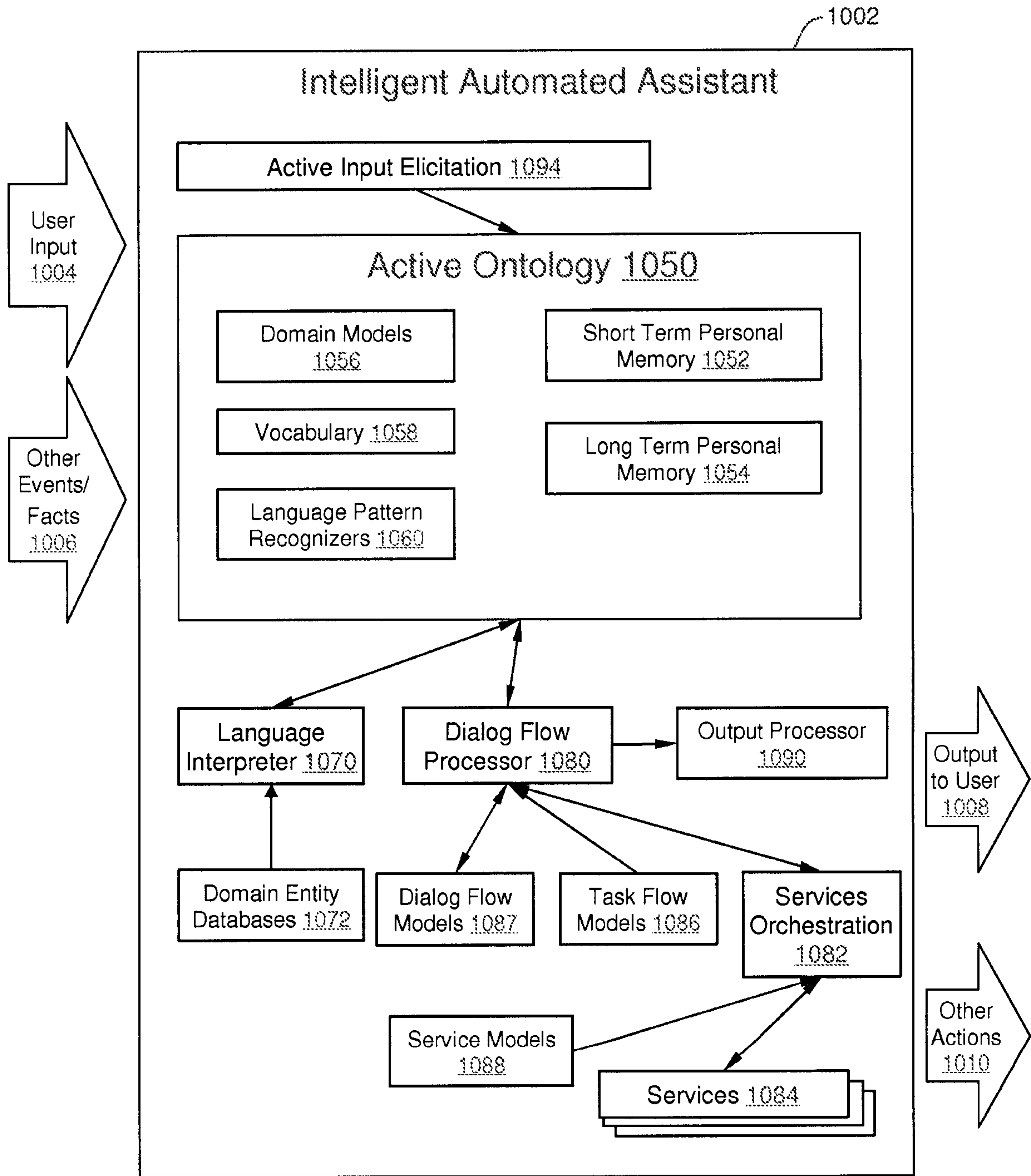

FIG. 9

10 / 47

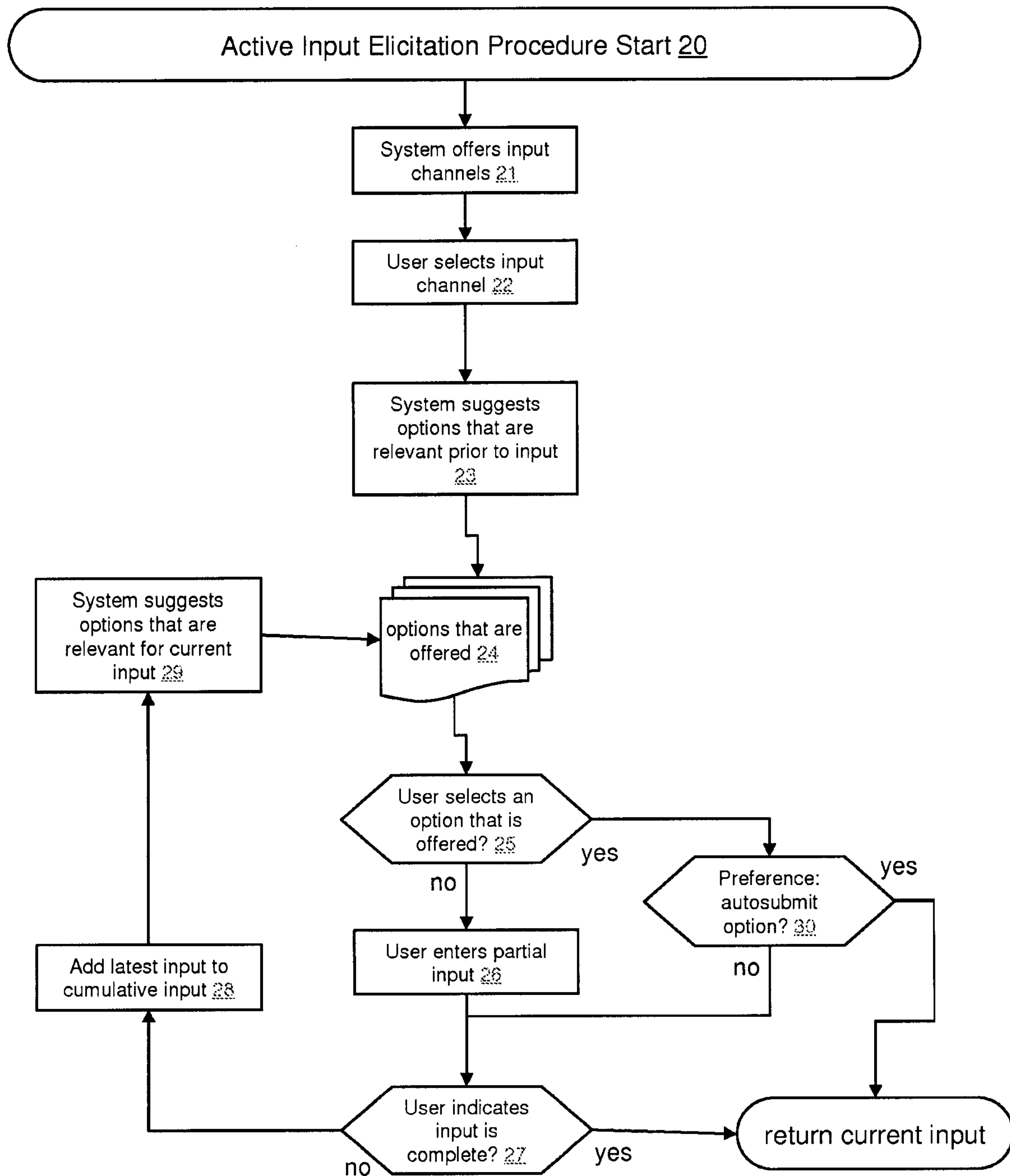

FIG. 10

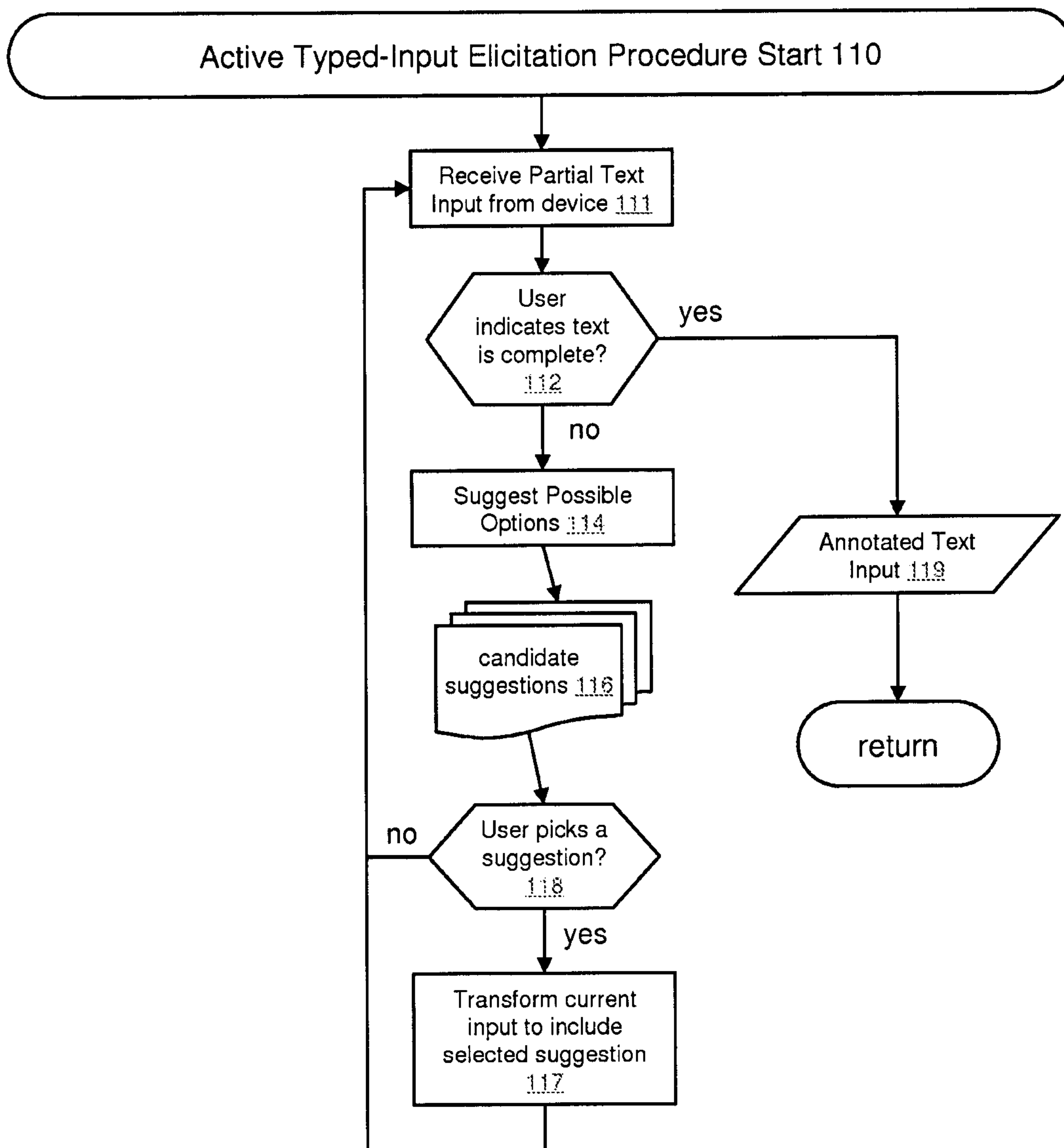

FIG. 11

12 / 47

1201

1202

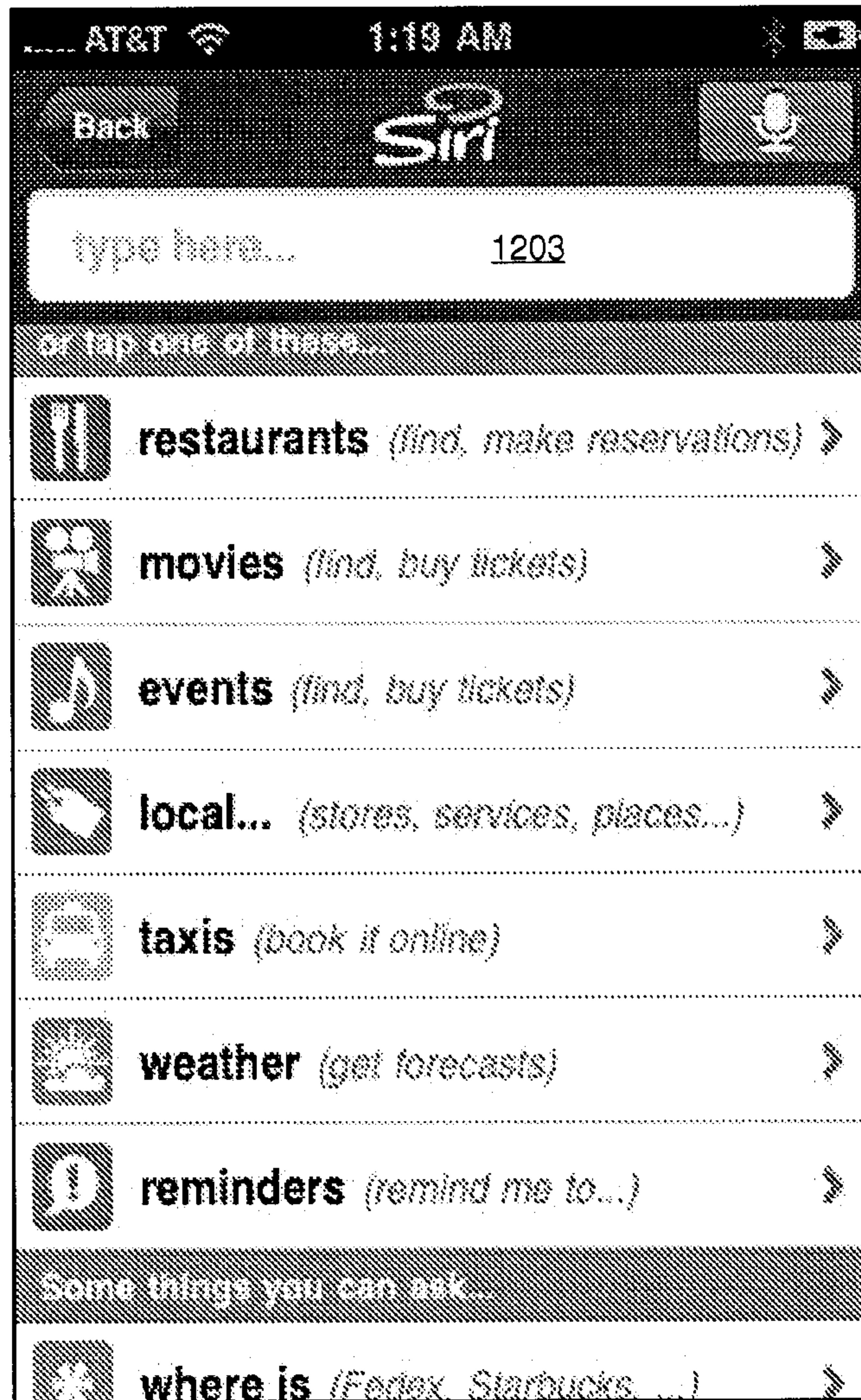

FIG. 12

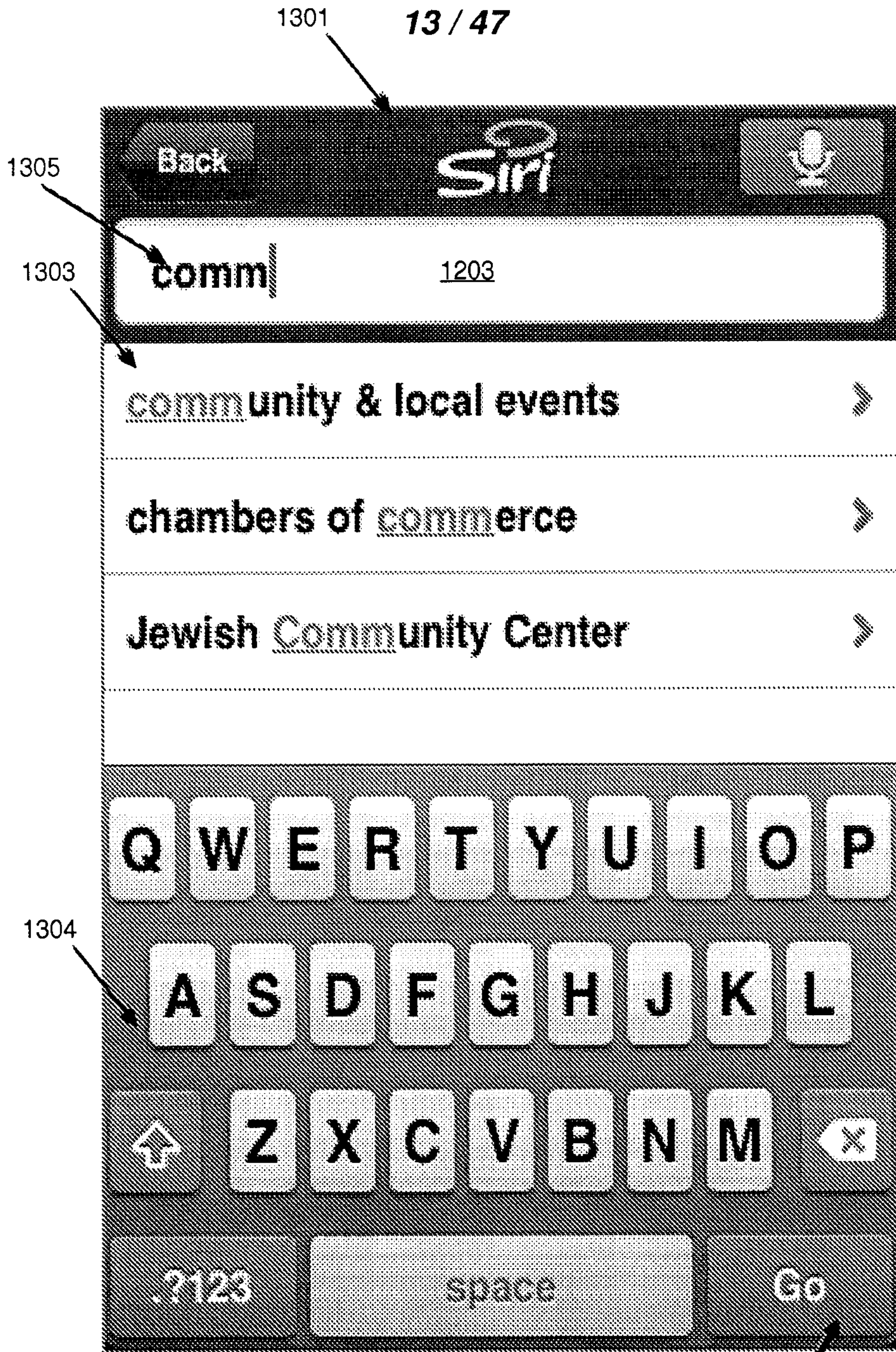

FIG. 13

1306



14 / 47

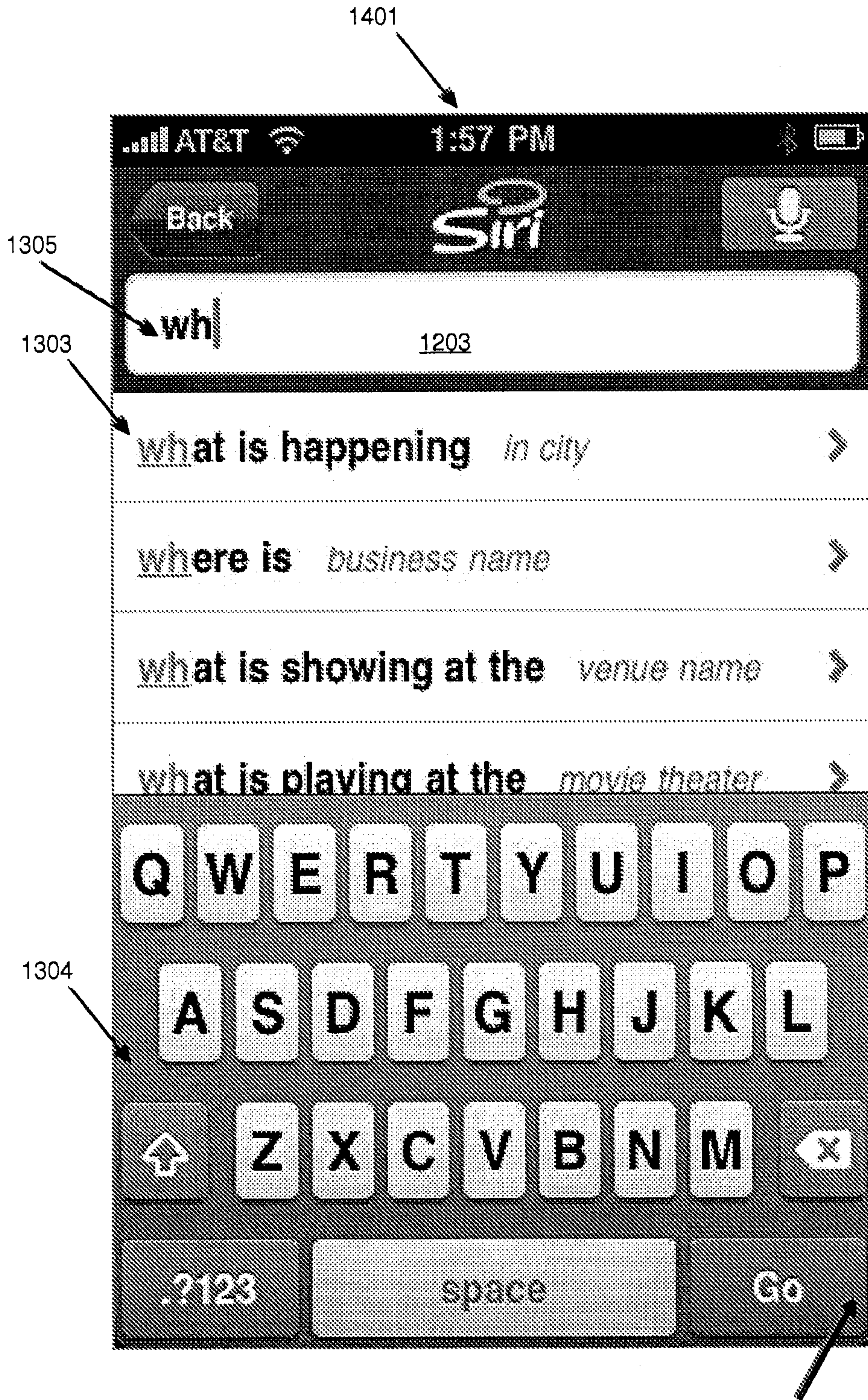
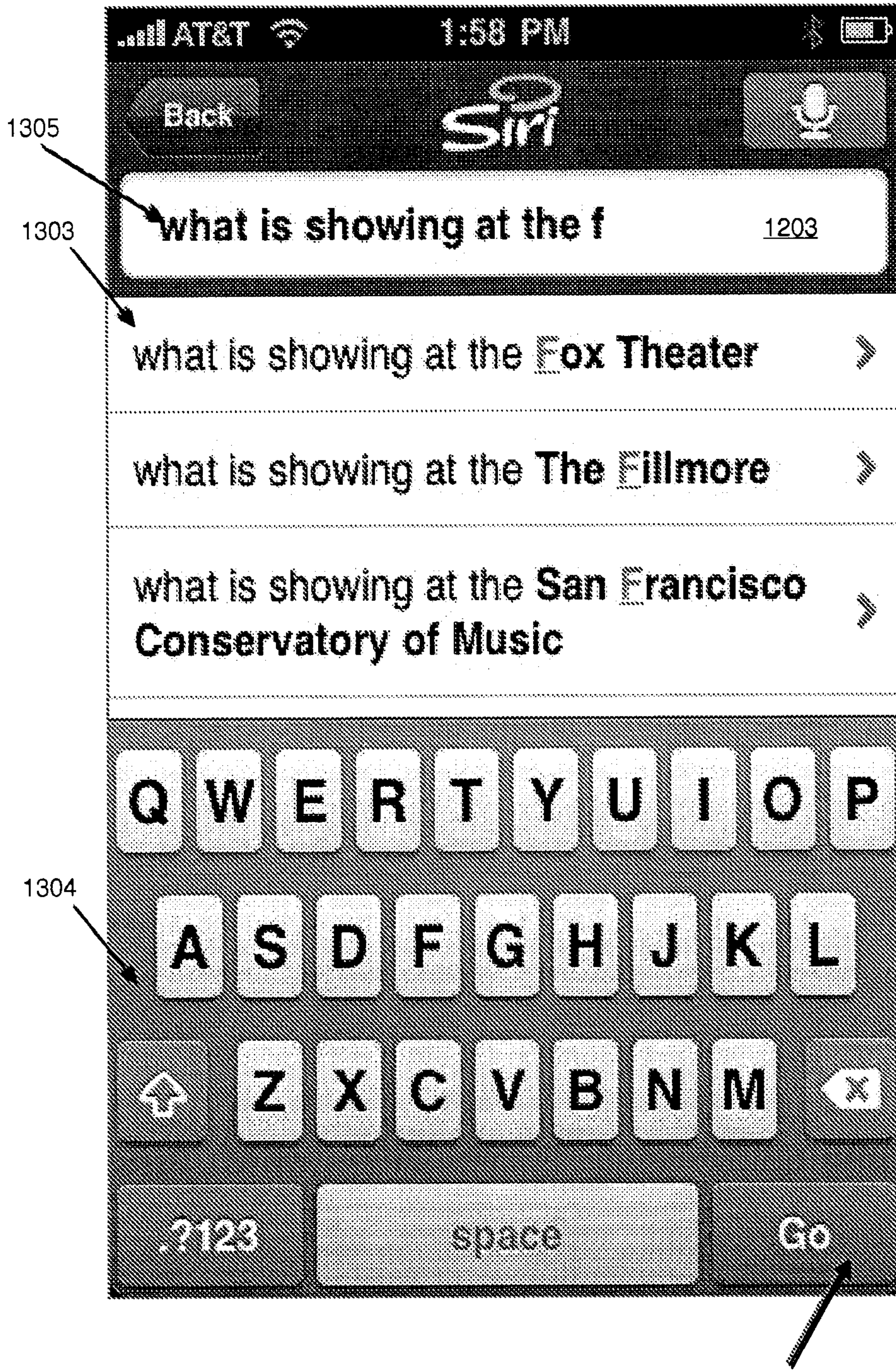

FIG. 14

1306

15 / 47

1501



1305

1303

1304

1306

FIG. 15

16 / 47

1601

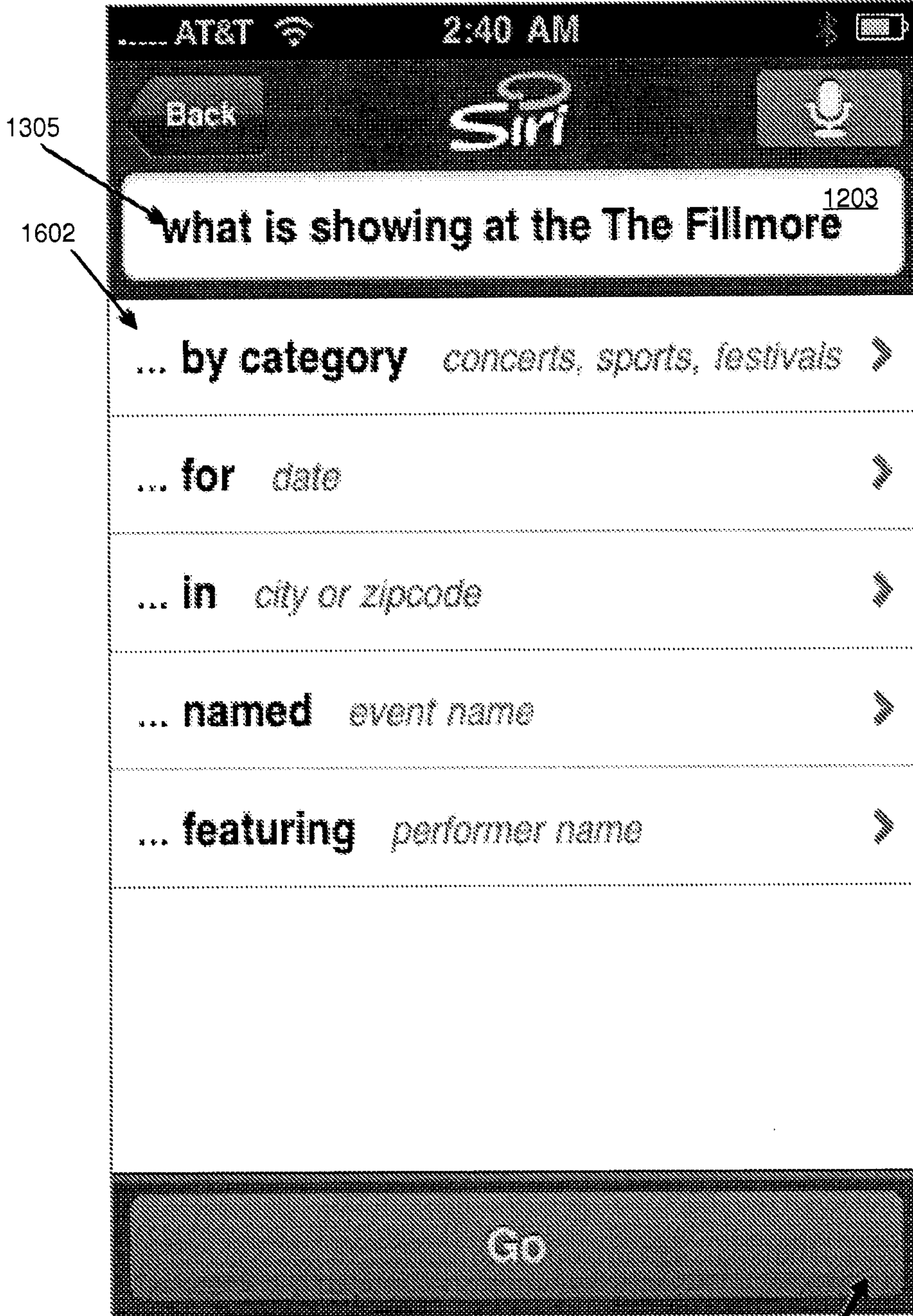

1305

1602

1203

FIG. 16

1306

17 / 47

1701

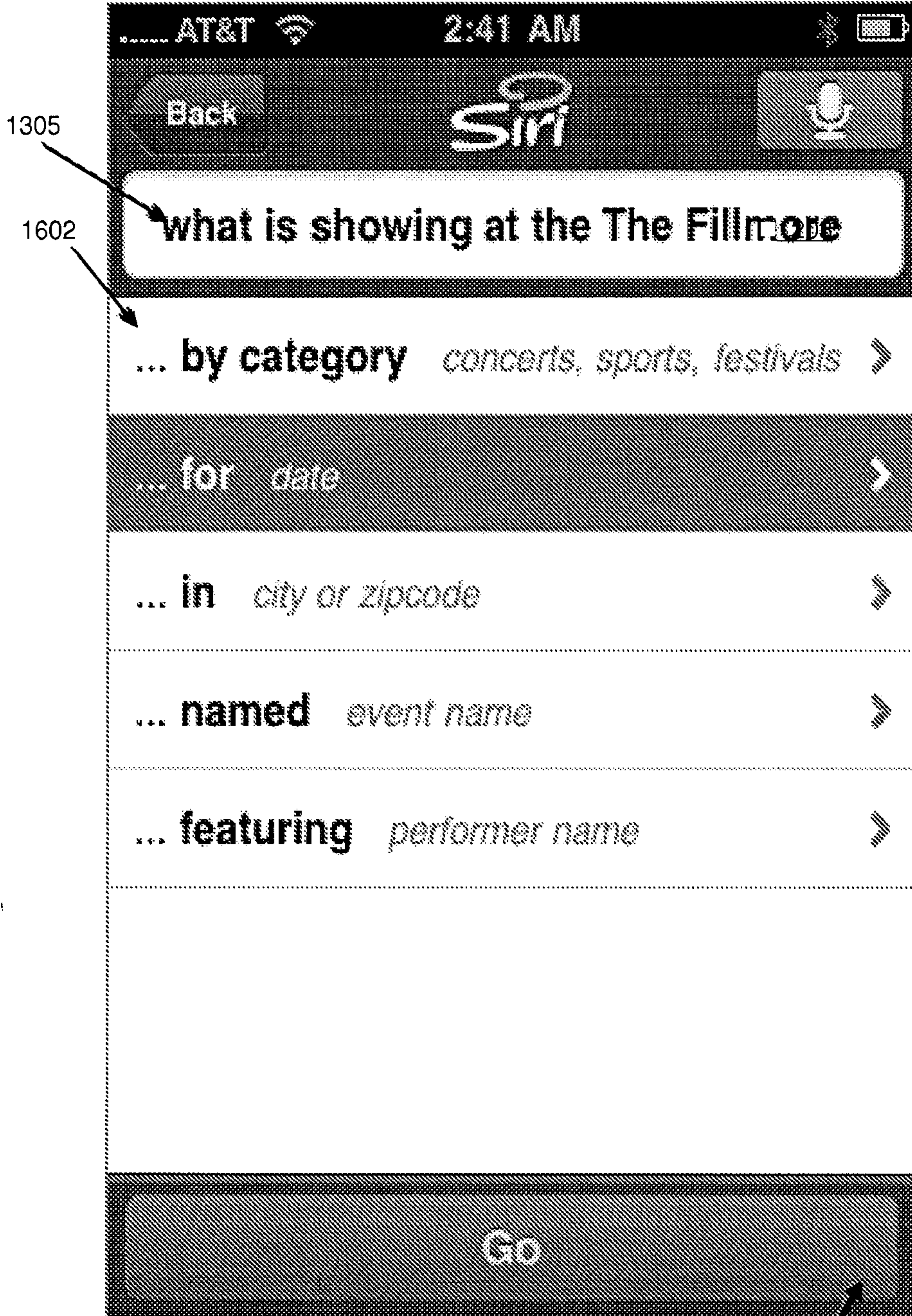

FIG. 17

1306

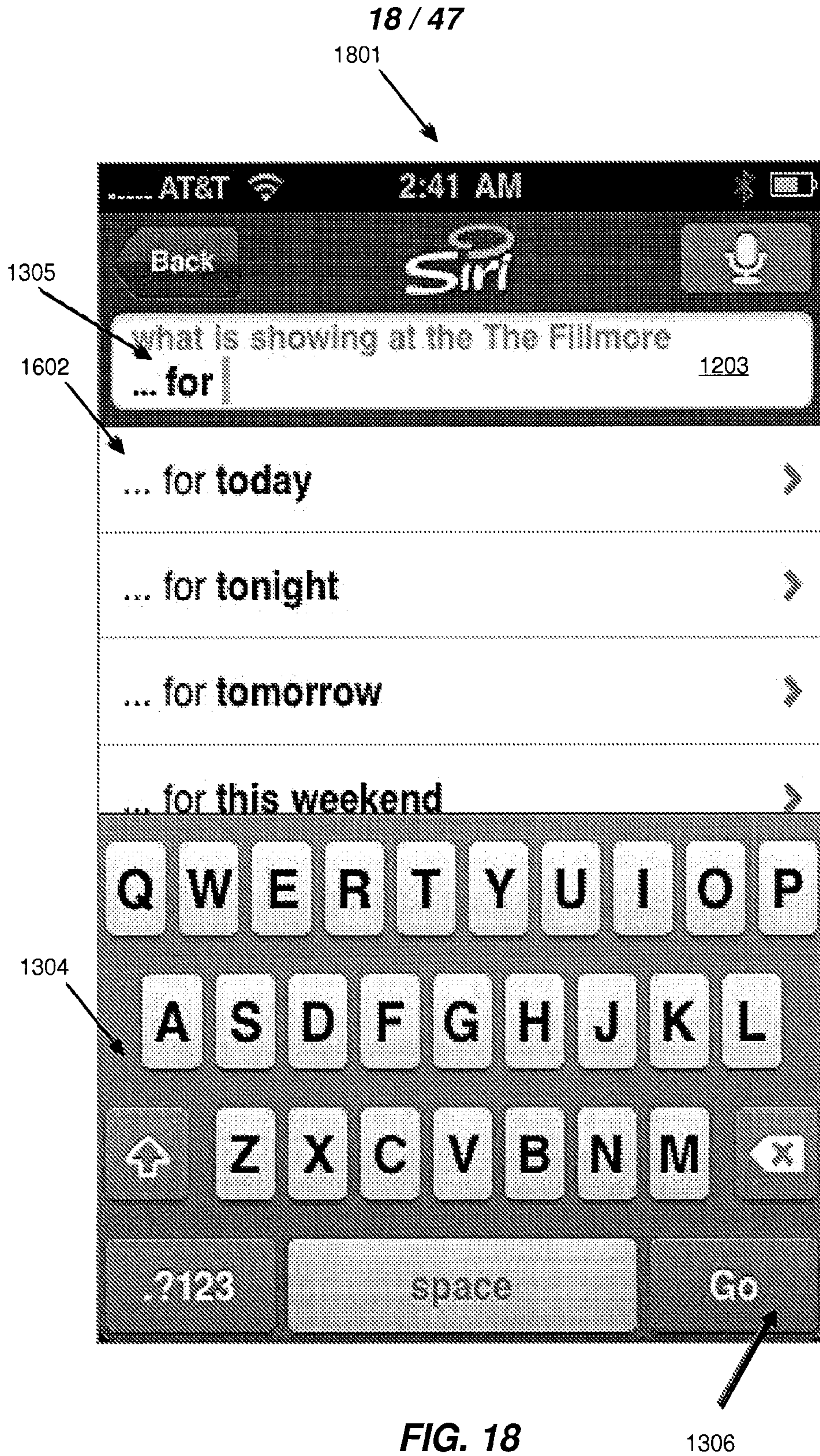
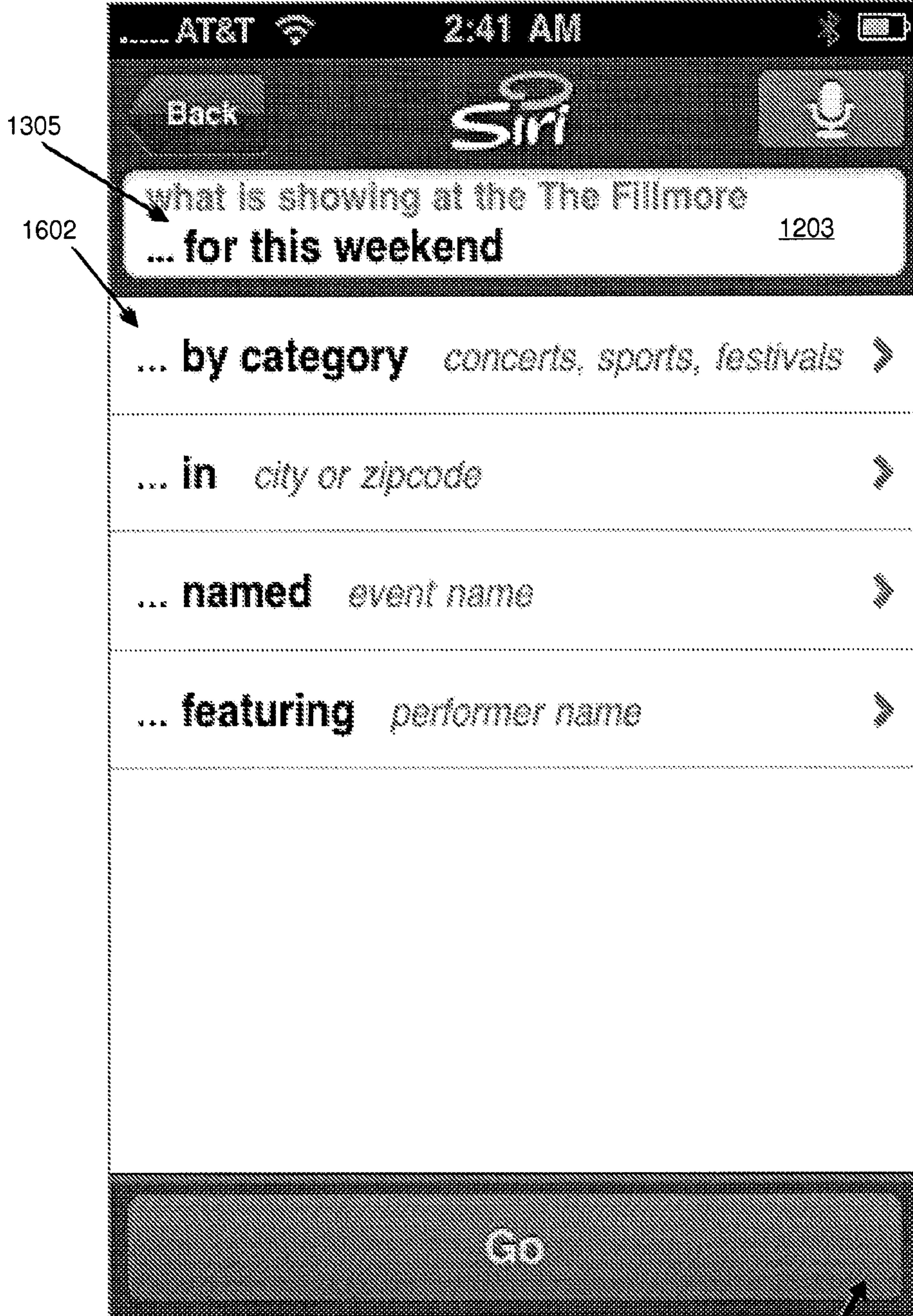

FIG. 18

19 / 47

1901



1305

1602

FIG. 19

1306



FIG. 20



FIG. 21



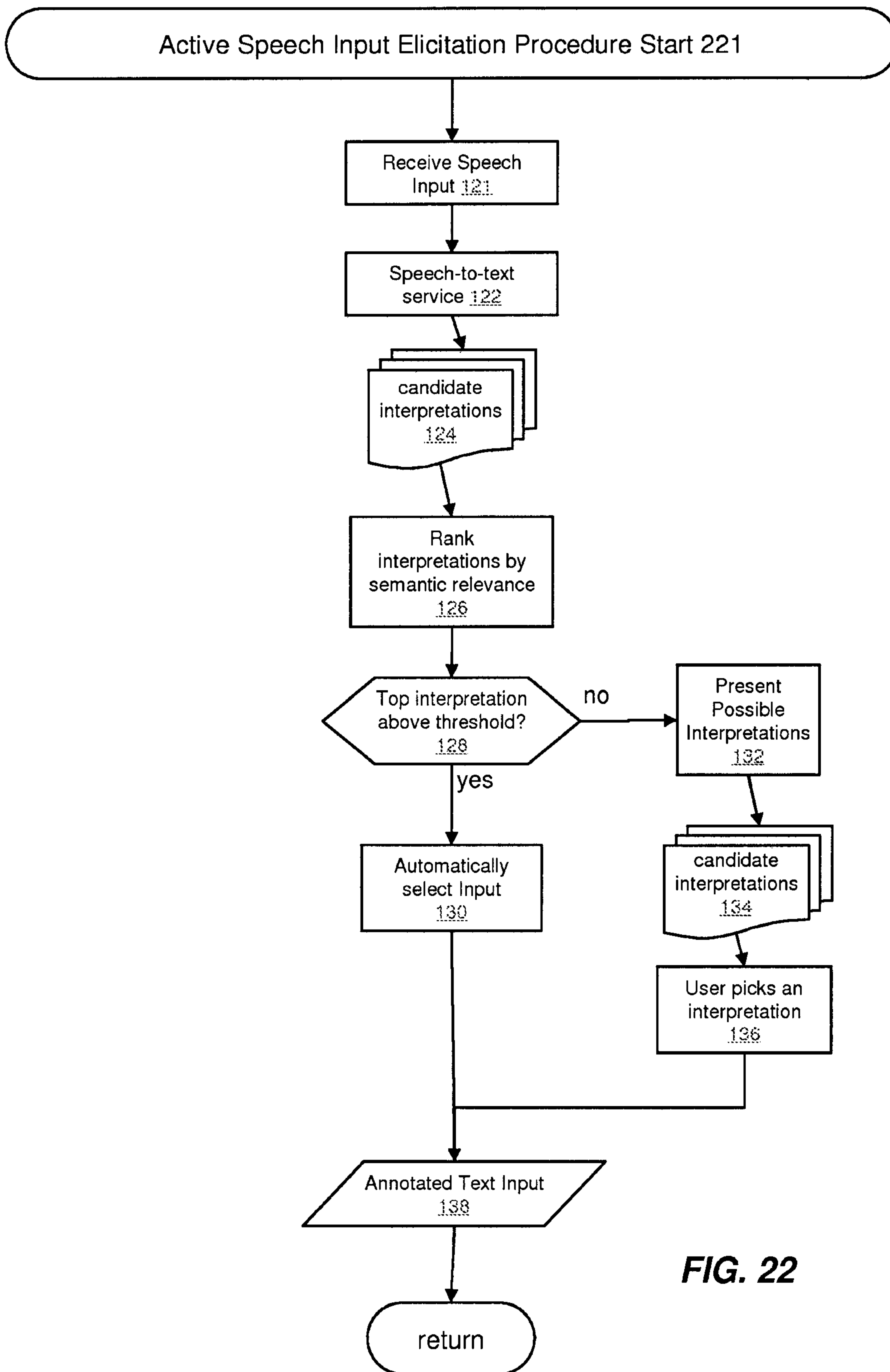

FIG. 22

23 / 47

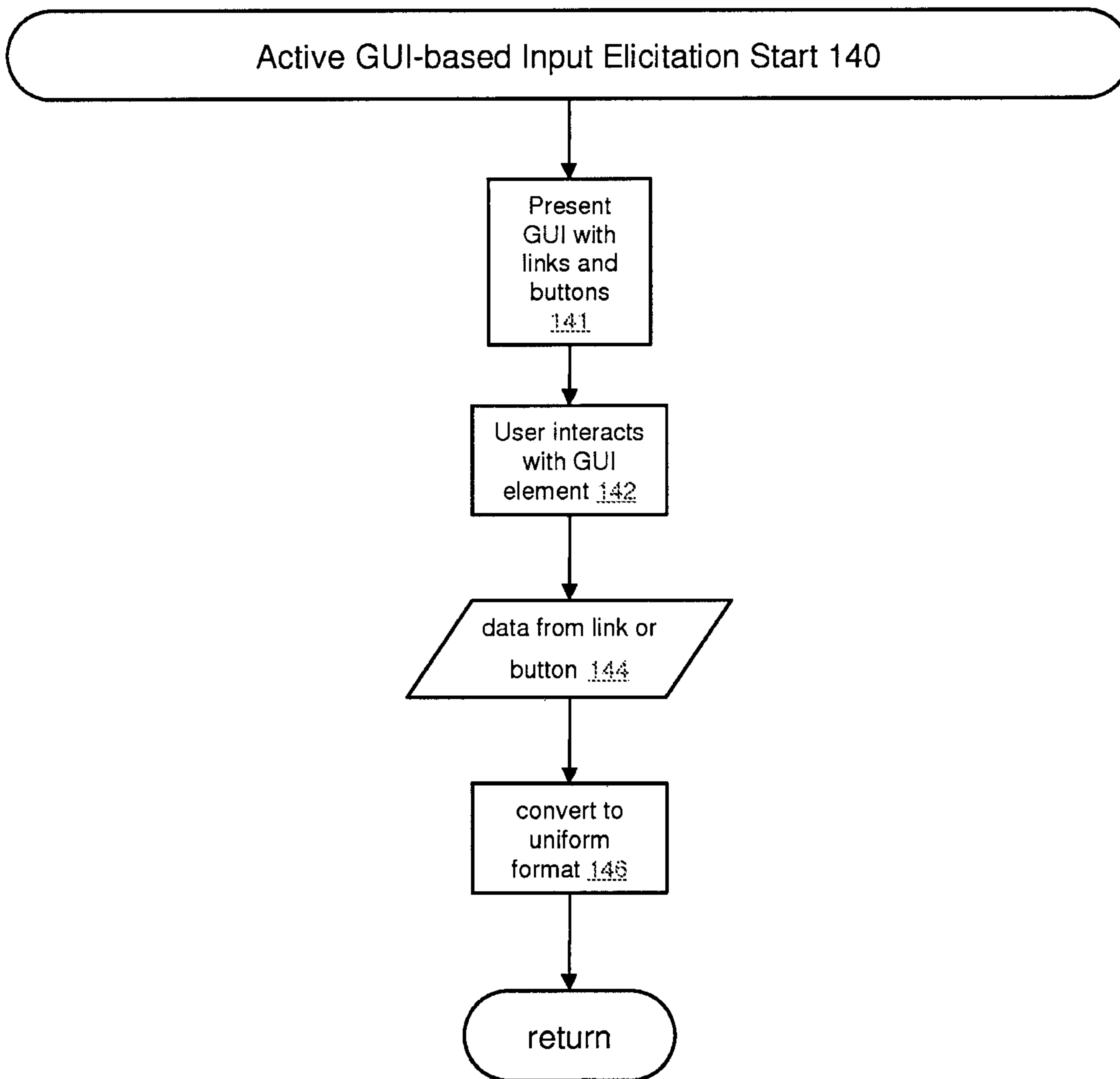
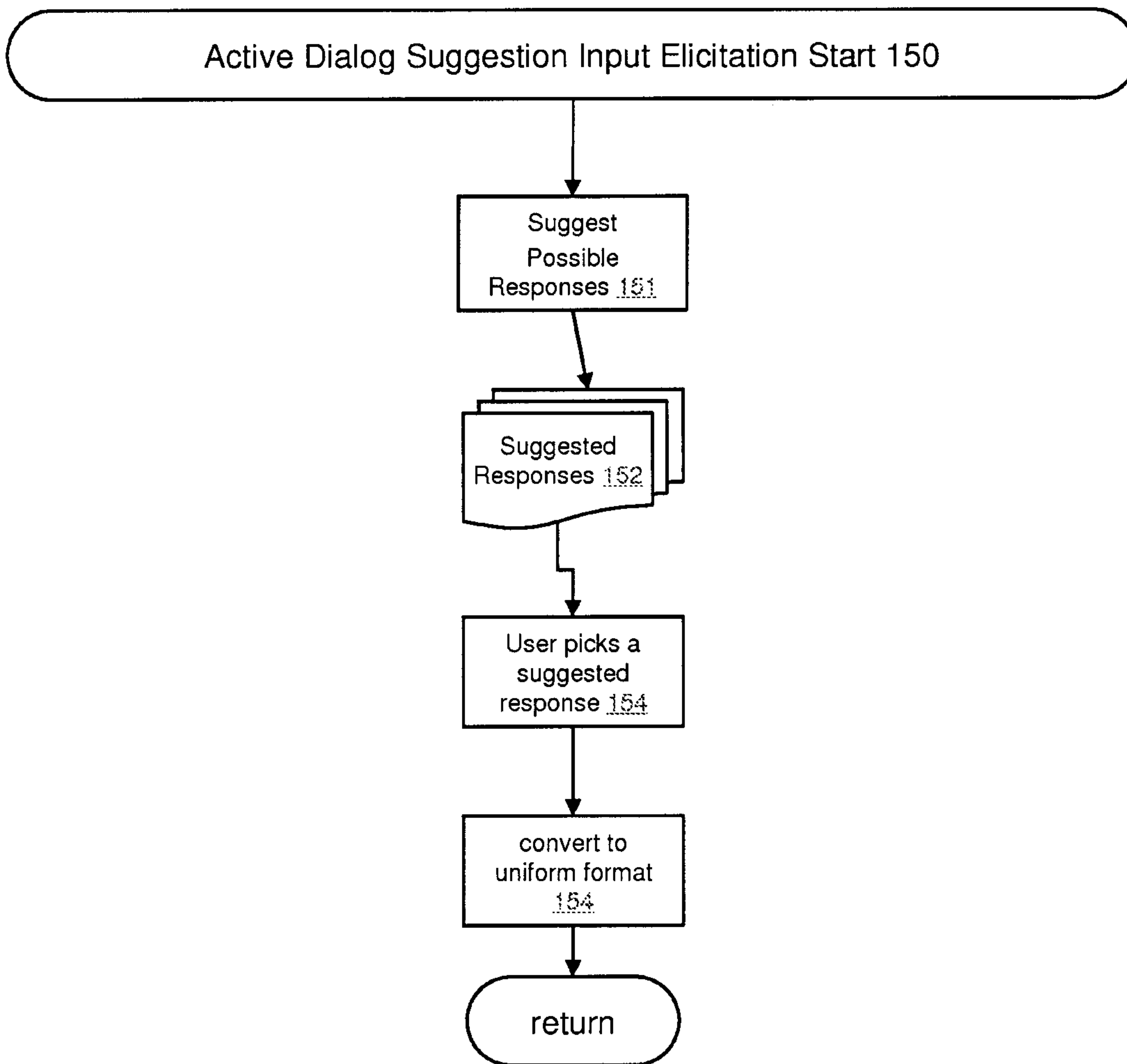

FIG. 23



**FIG. 24**

25 / 47

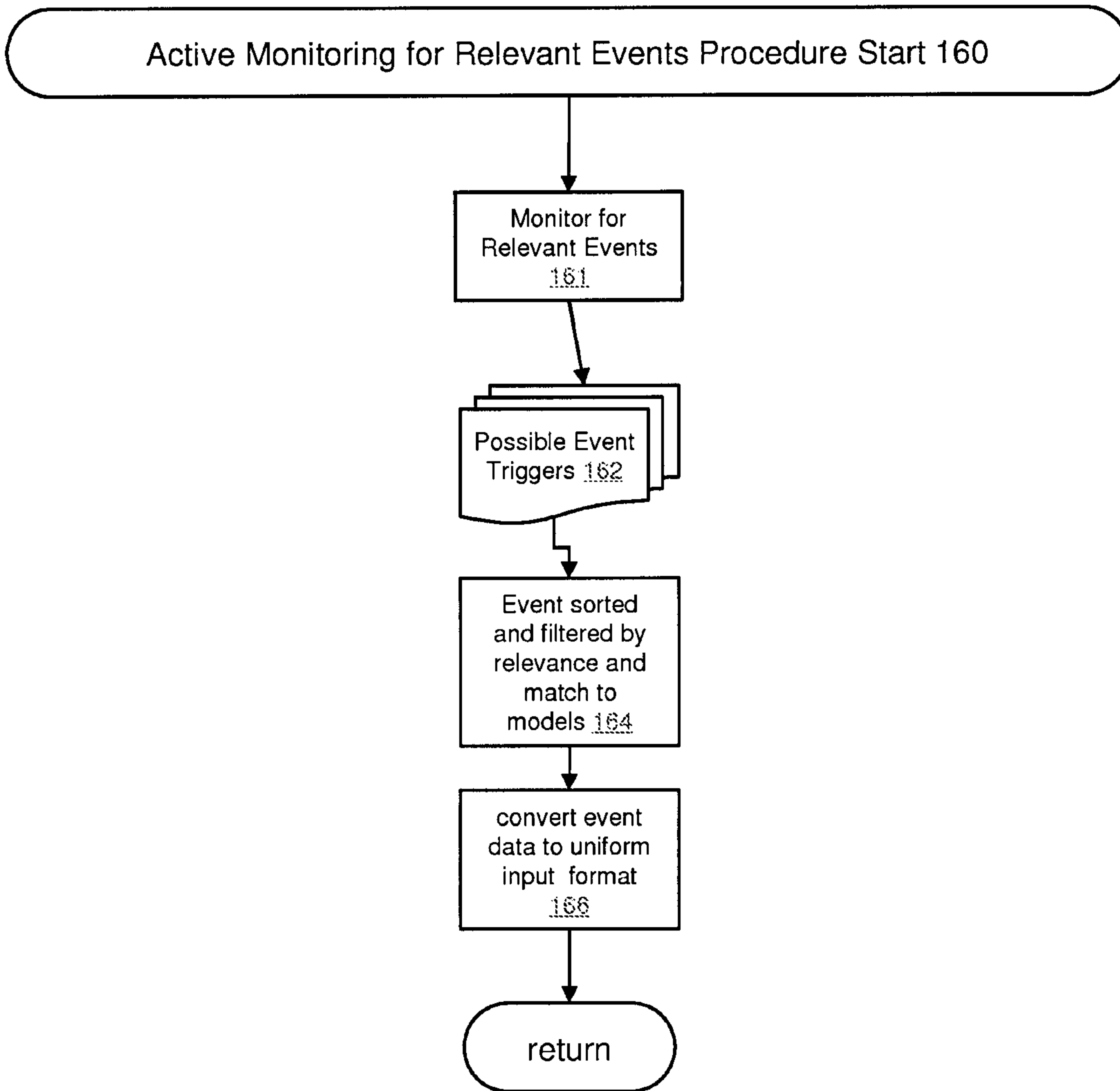

FIG. 25

26 / 47

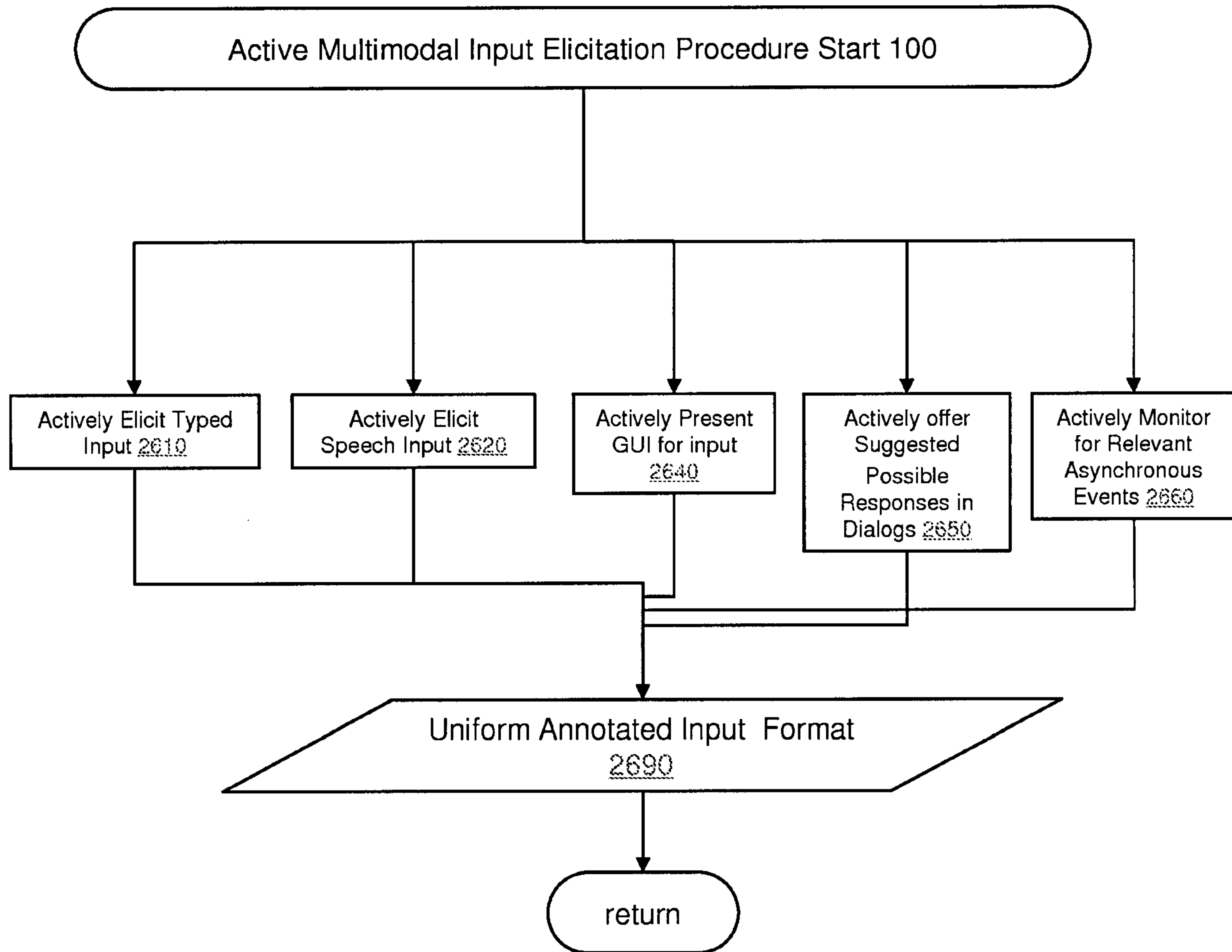

FIG. 26

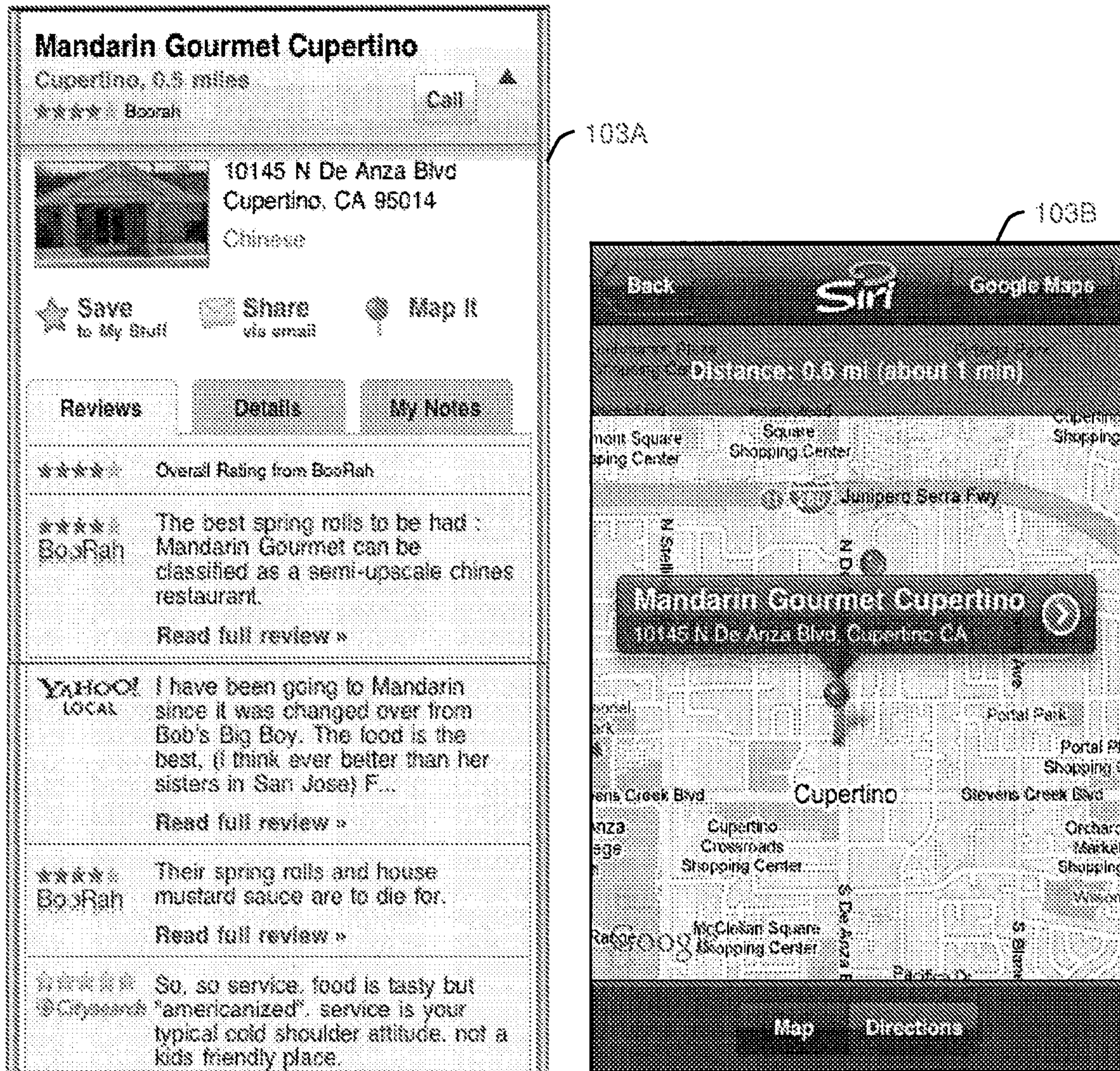

FIG. 27

28 / 47

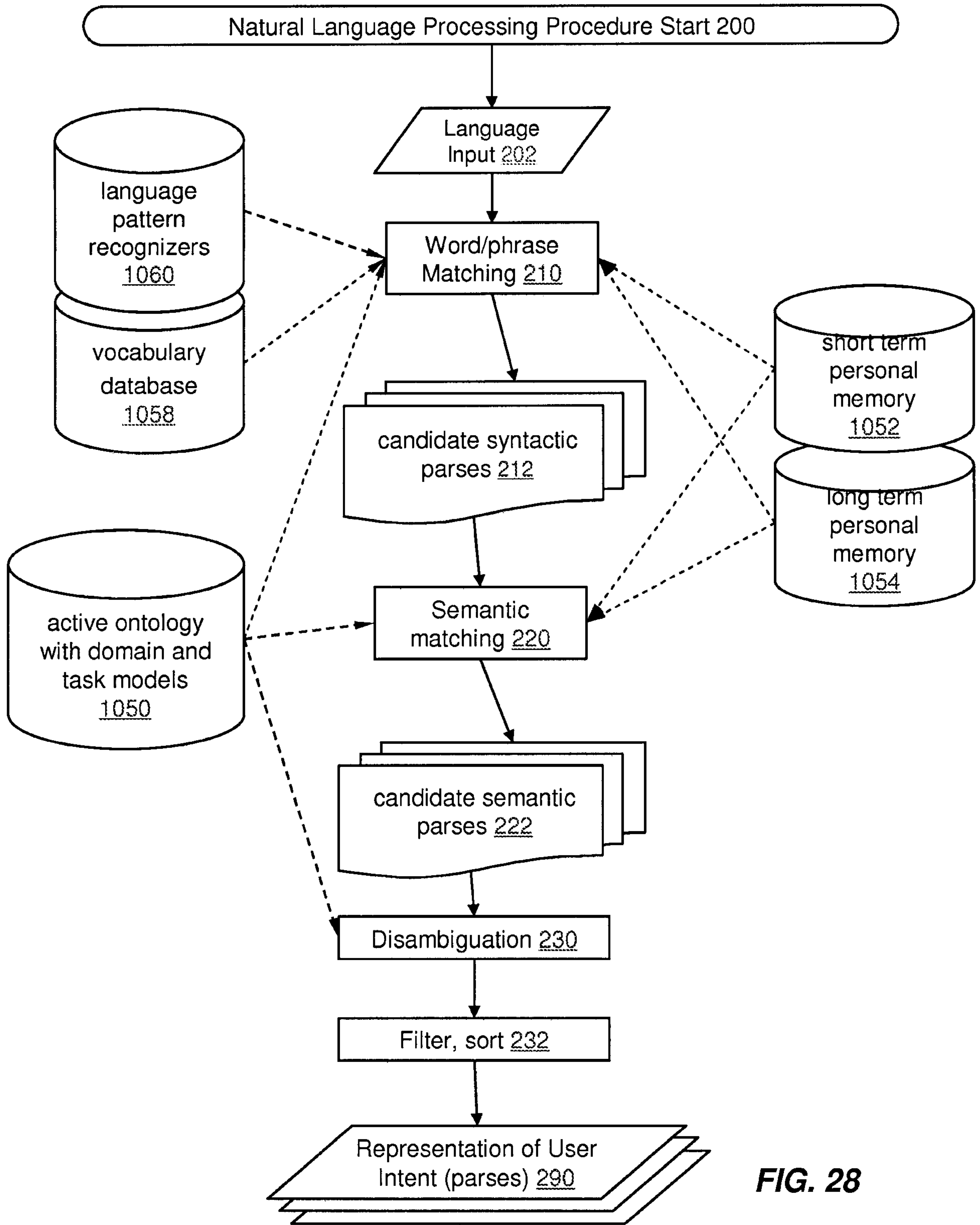

FIG. 28

29 / 47



FIG. 29



30 / 47

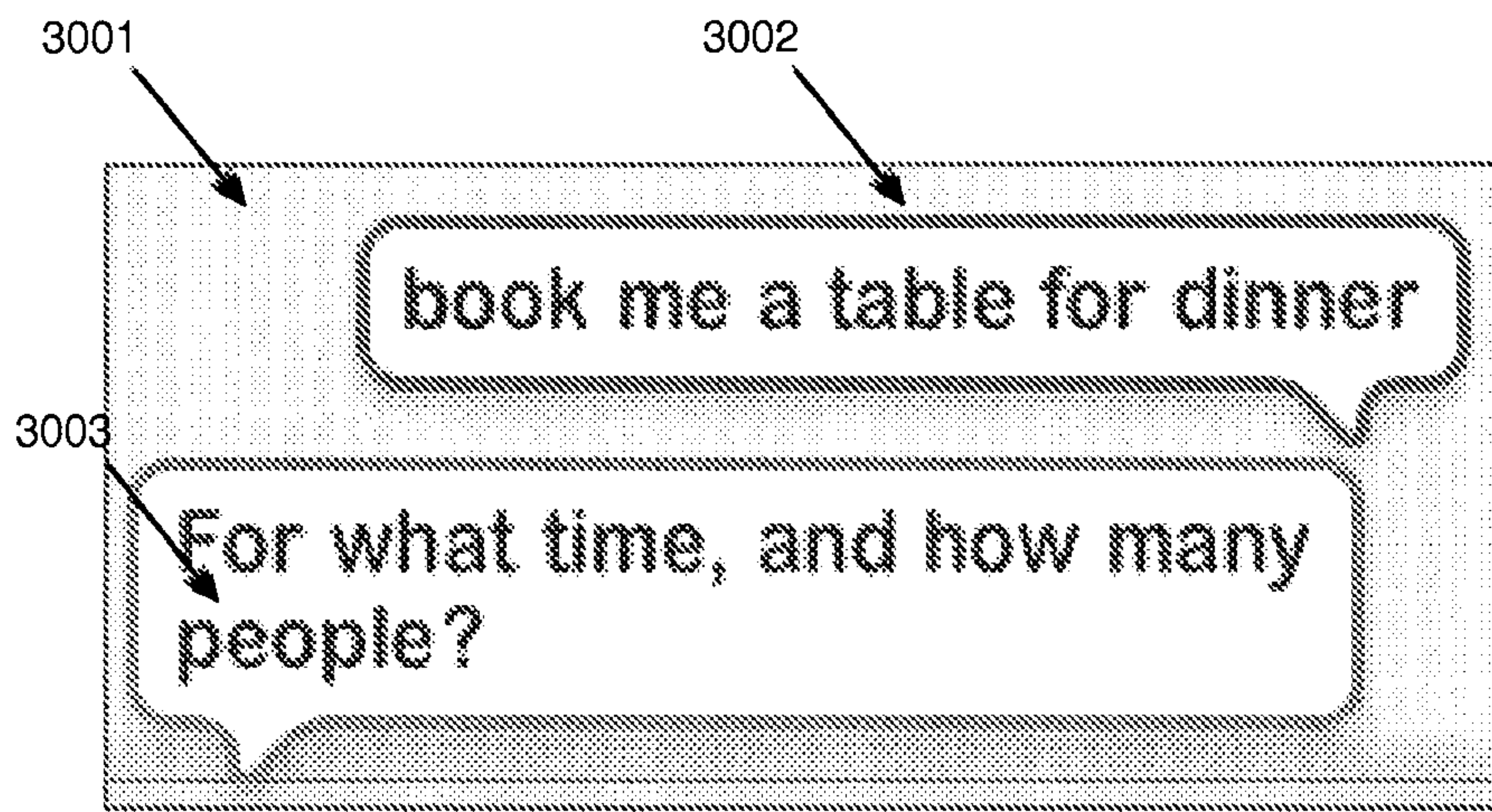

**FIG. 30**

31 / 47

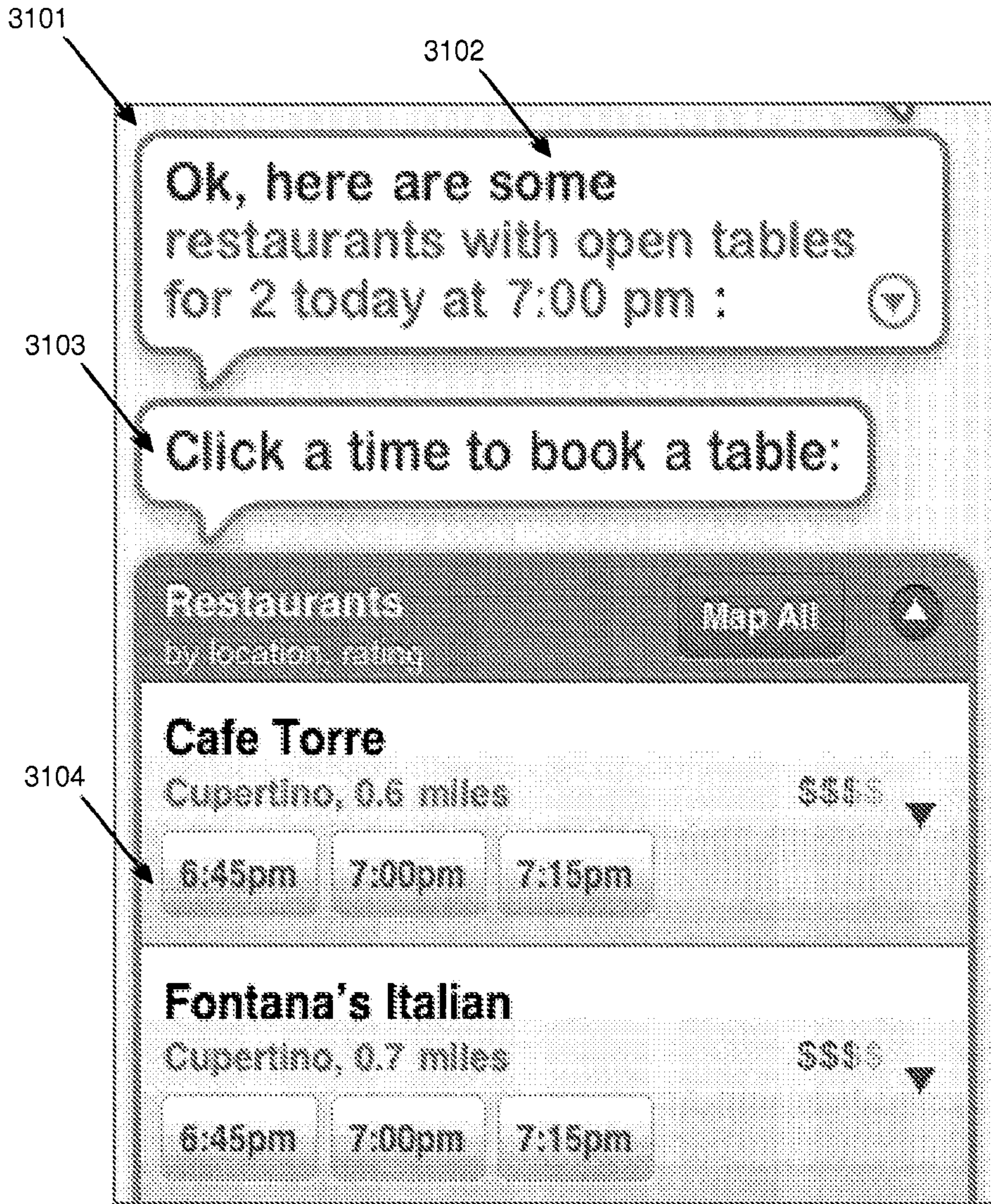

FIG. 31

32 / 47

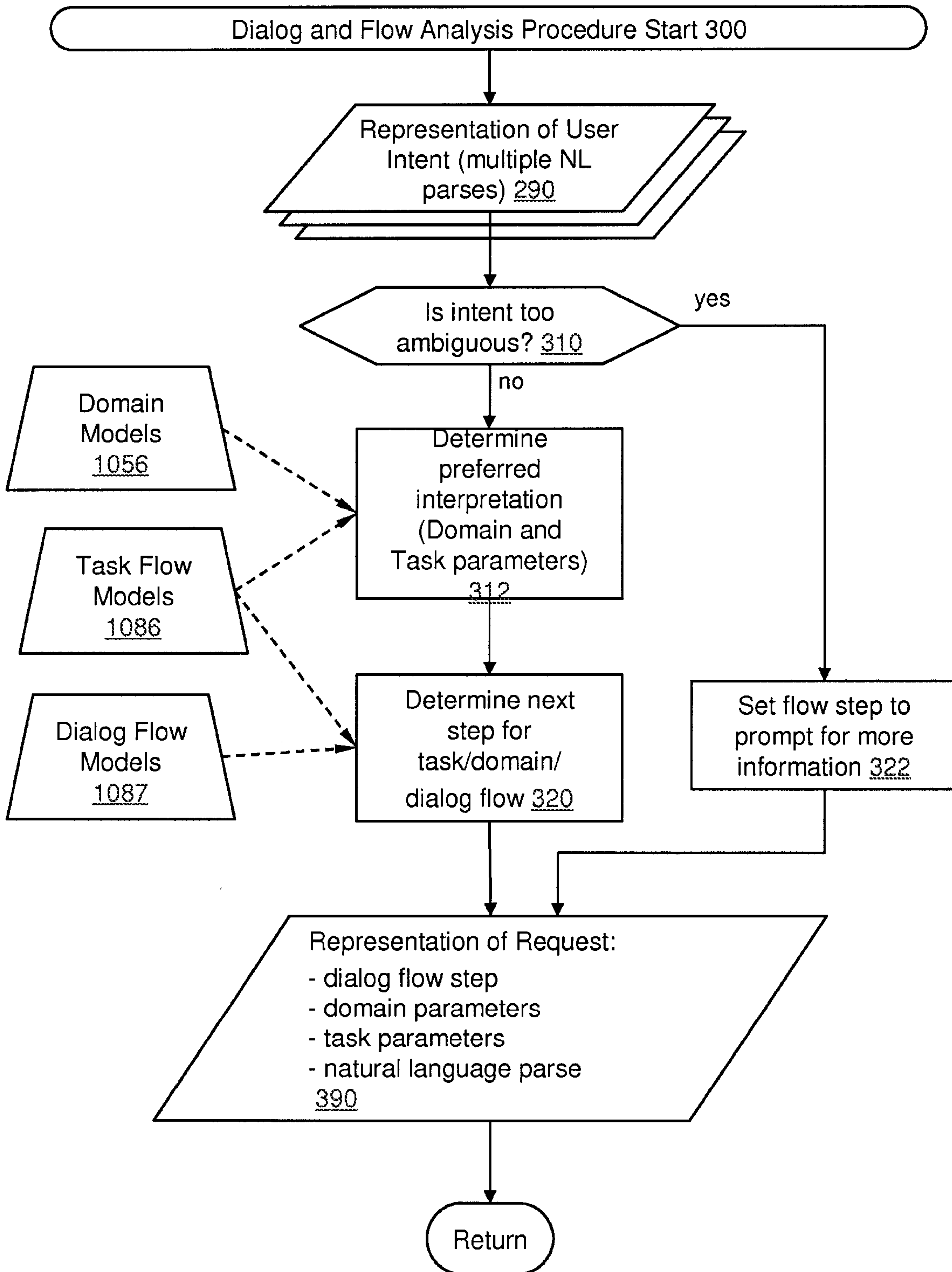

FIG. 32

10

33 / 47

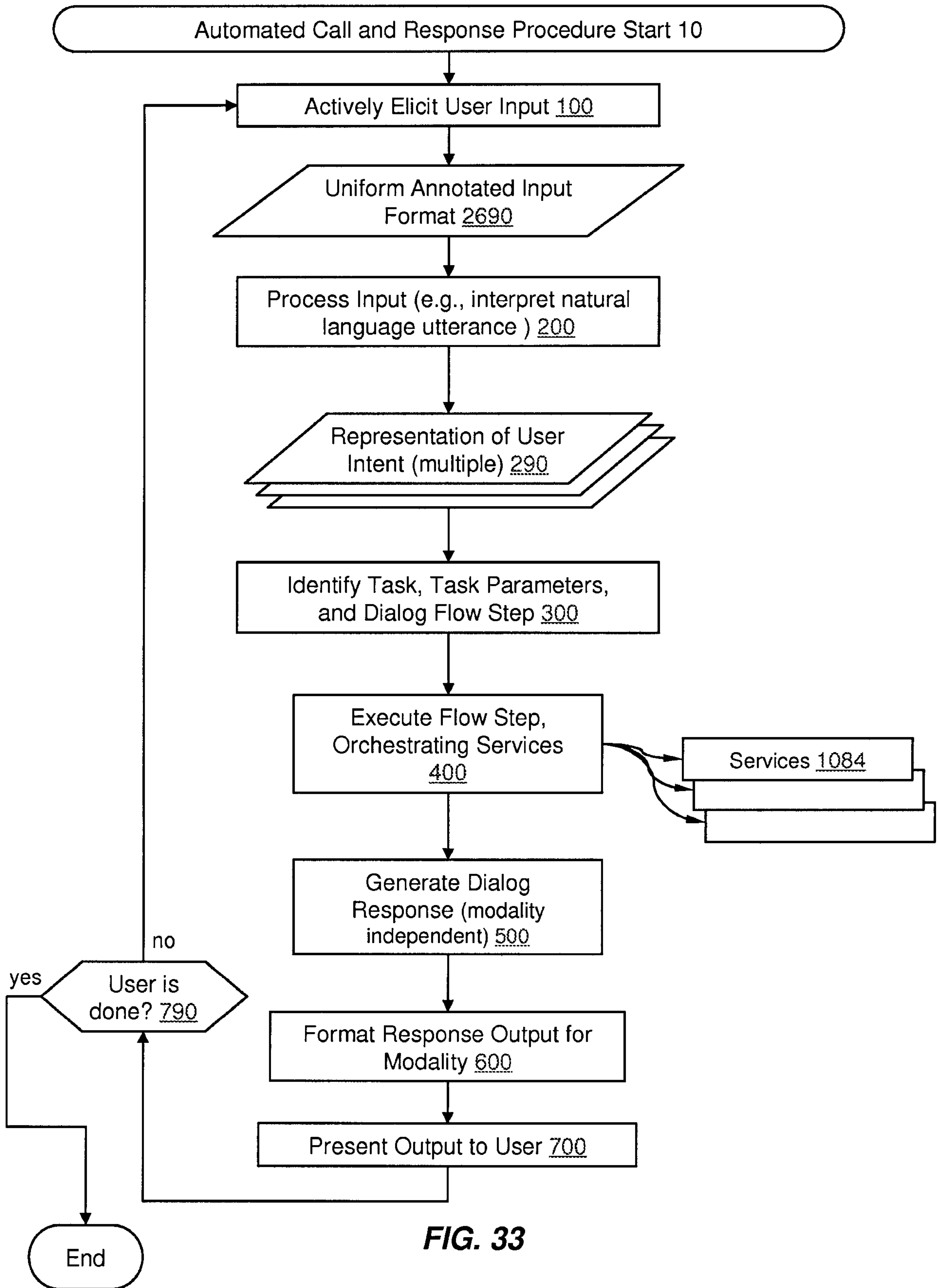

FIG. 33

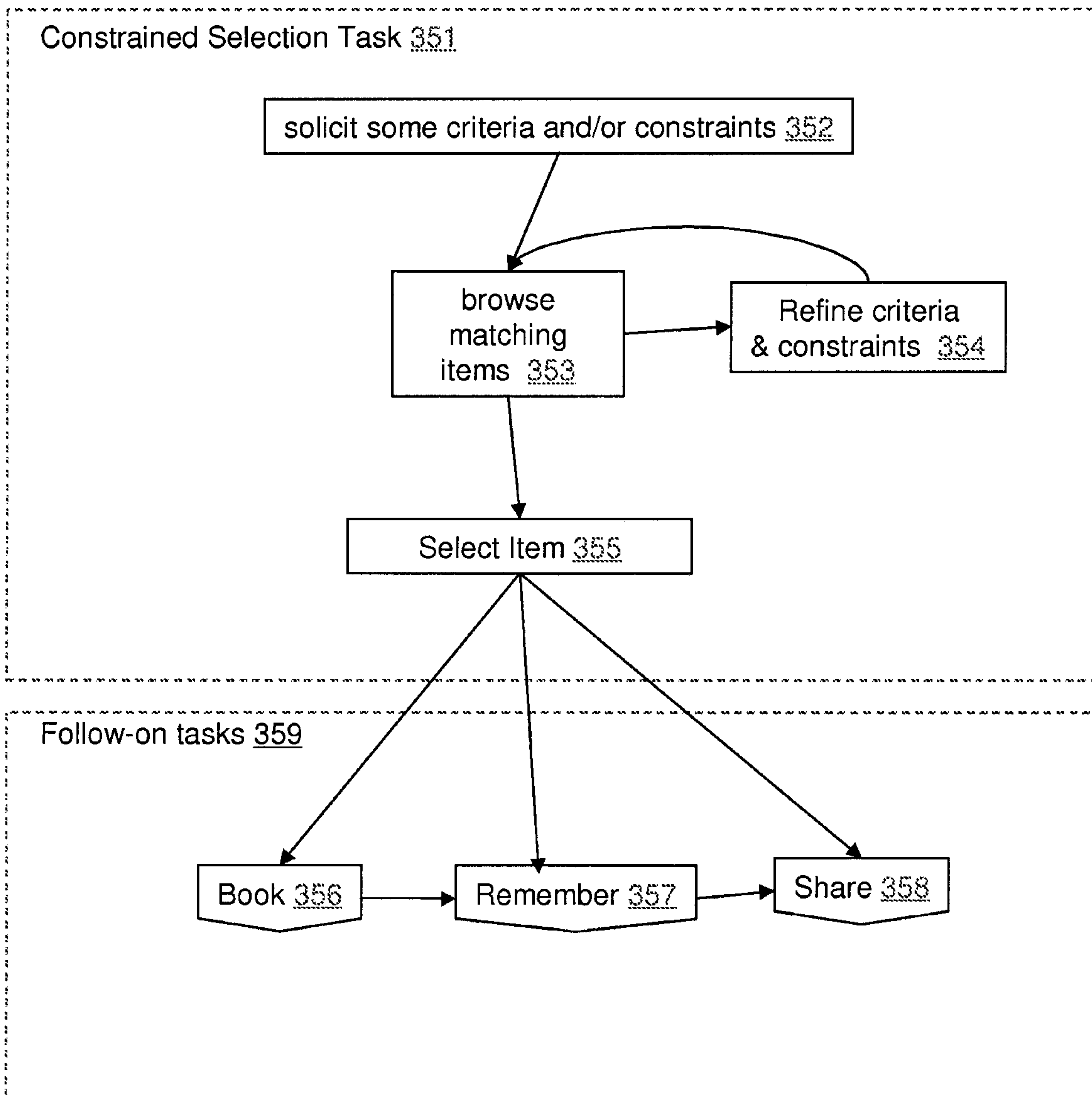
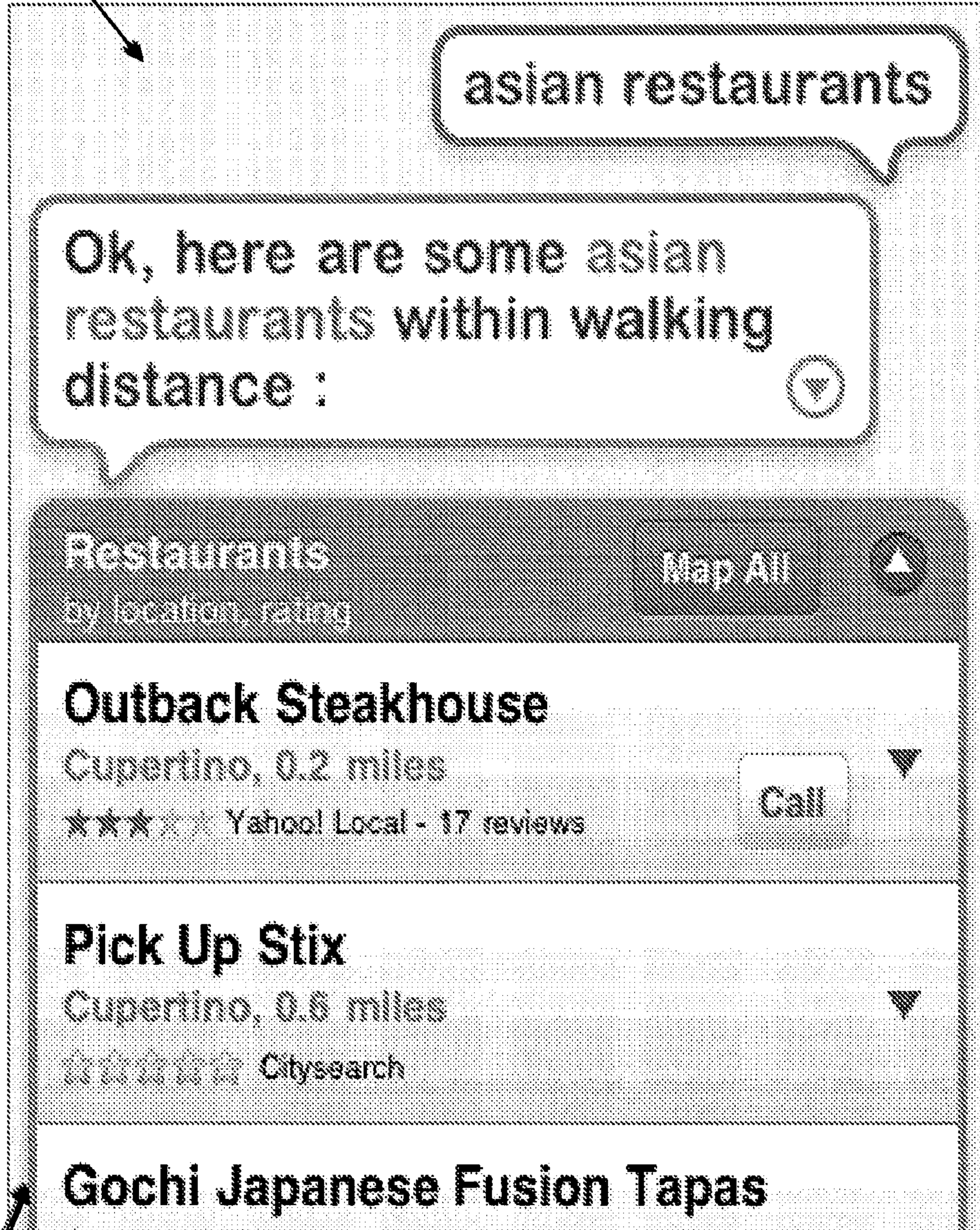

FIG. 34

3501



3502

FIG. 35

3601

### Gochi Japanese Fusion Tapas

Cupertino, 0.6 miles

Call

Yelp - 624 reviews

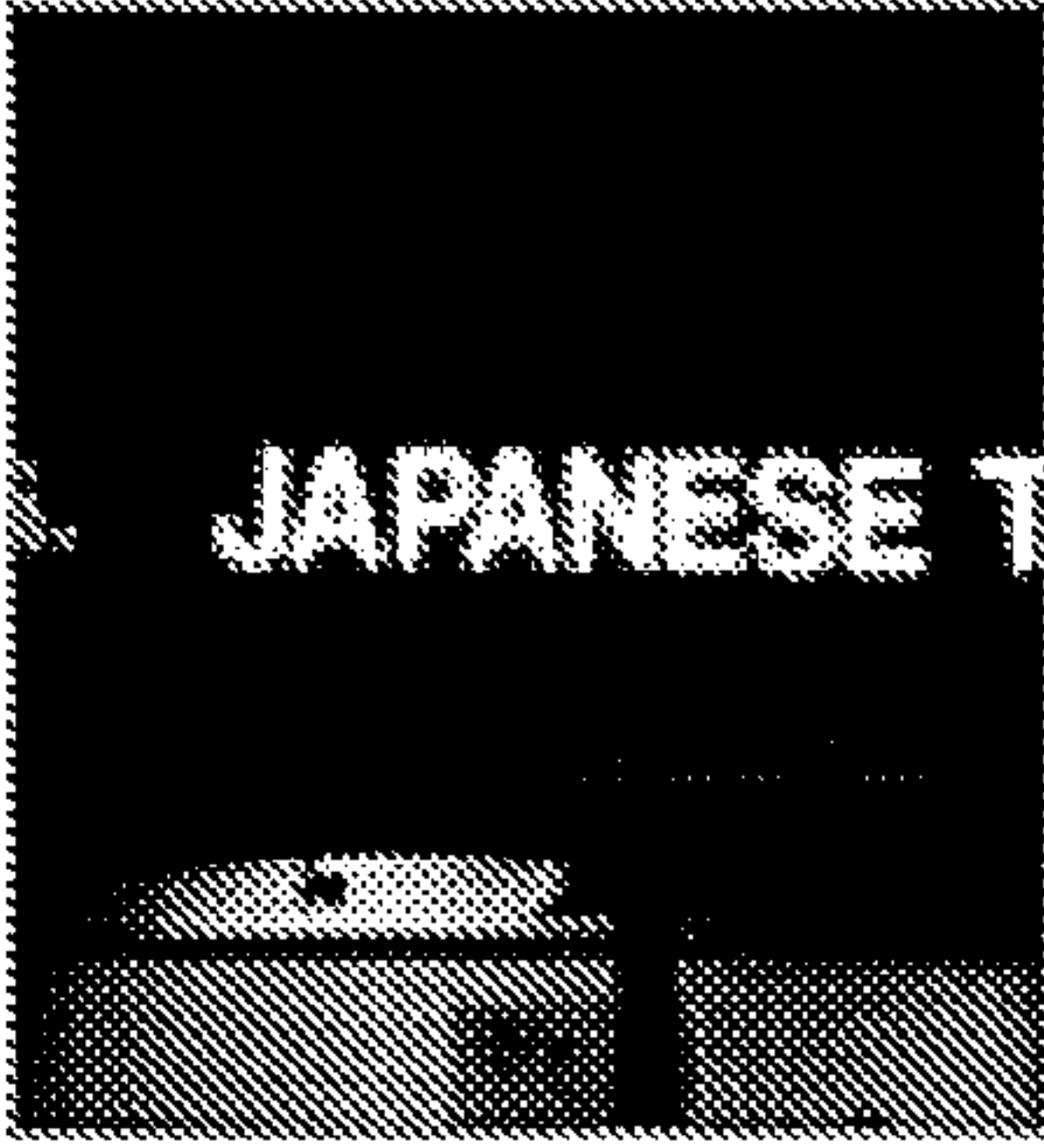

19980 E Homestead Rd  
Cupertino, CA 95014

Japanese

★ Save to My Stuff    ✉ Share via email    📍 Map It

Reviews    Details    My Notes

Yelp rating averaged from 624 reviews  
read reviews on yelp

**YAHOO!**  
LOCAL    this place is really different from others : the atmosphere and food we got felt more authentic then all

FIG. 36

37 / 47

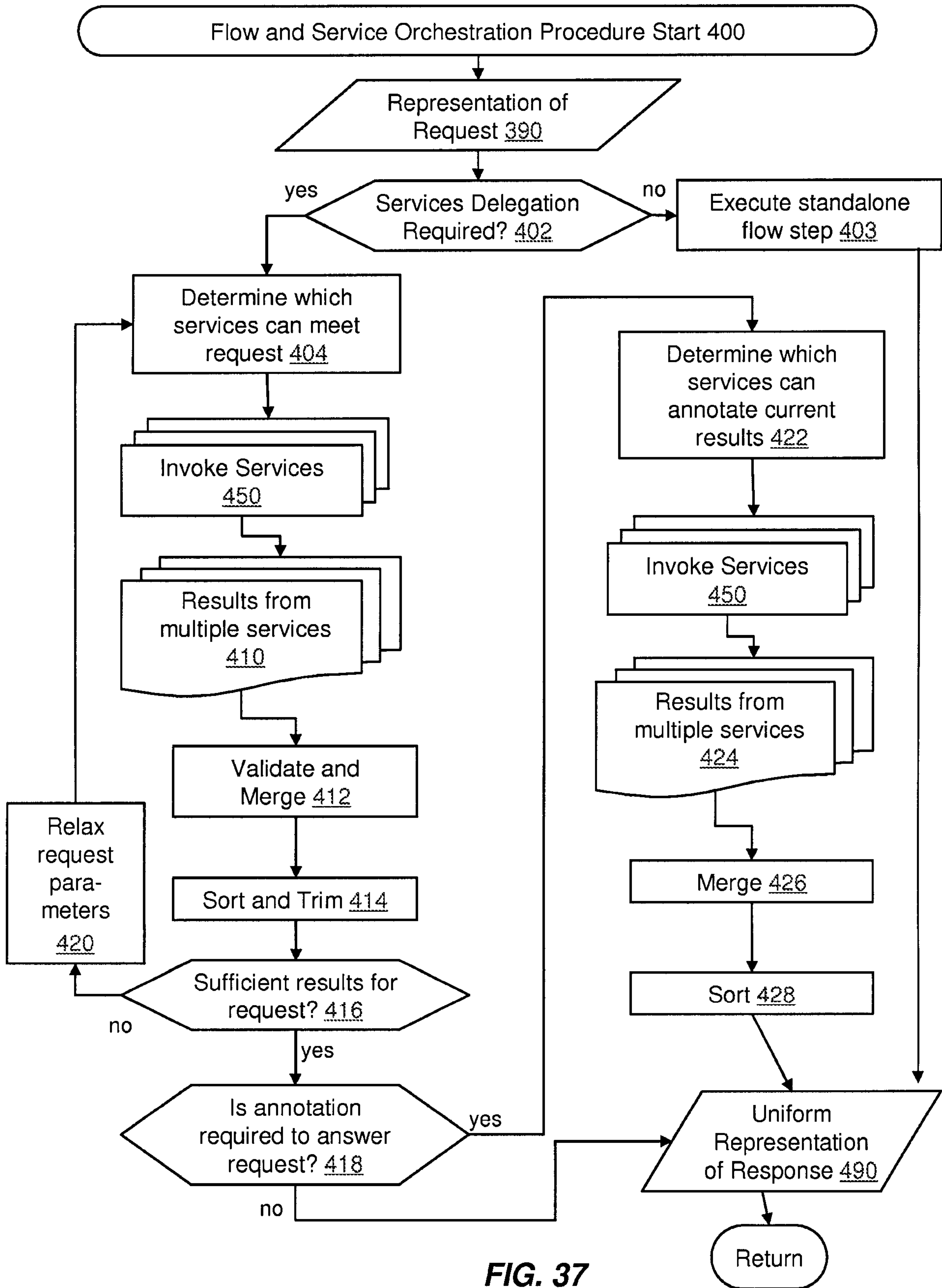
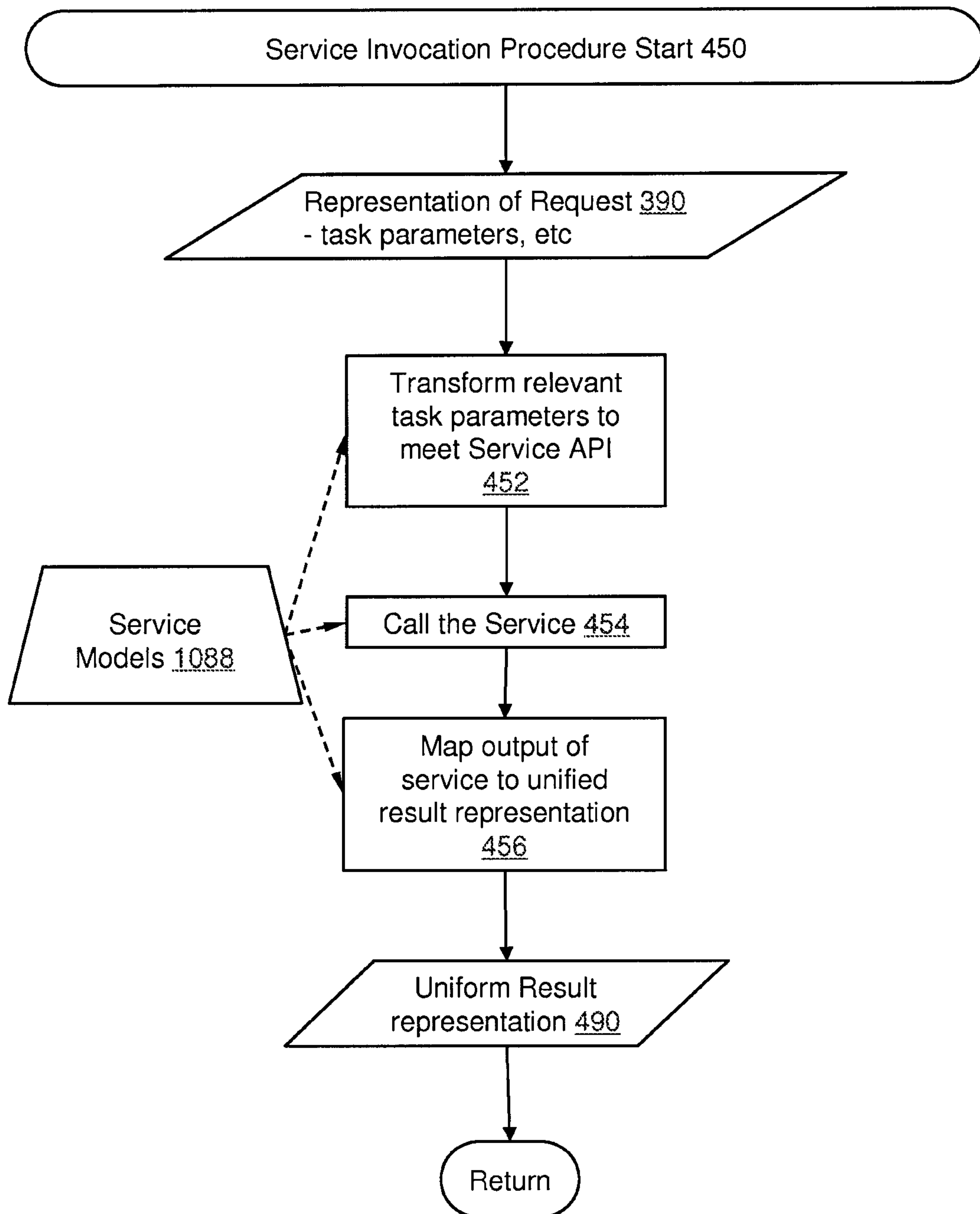

FIG. 37



**38 / 47****FIG. 38**

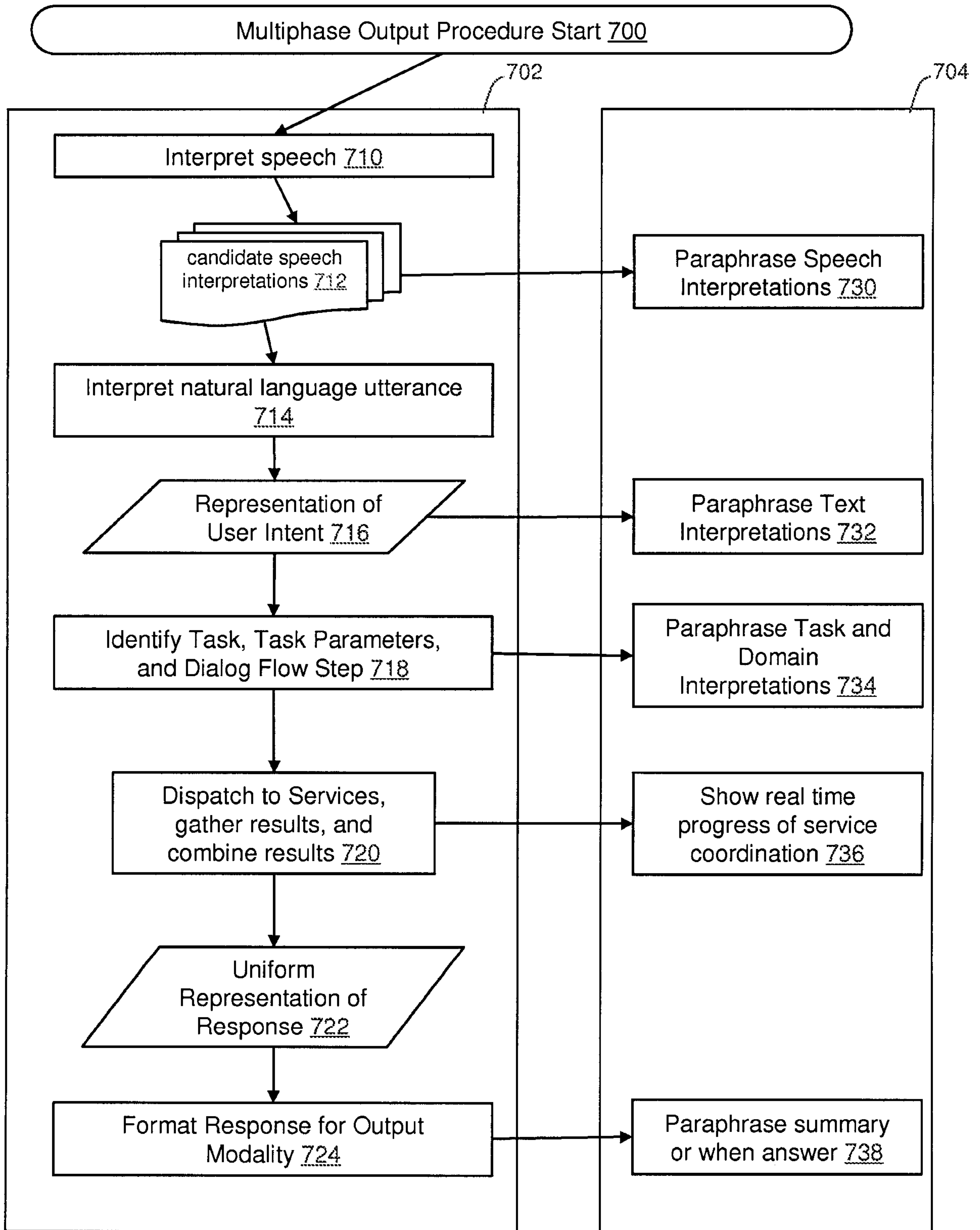

FIG. 39

40 / 47

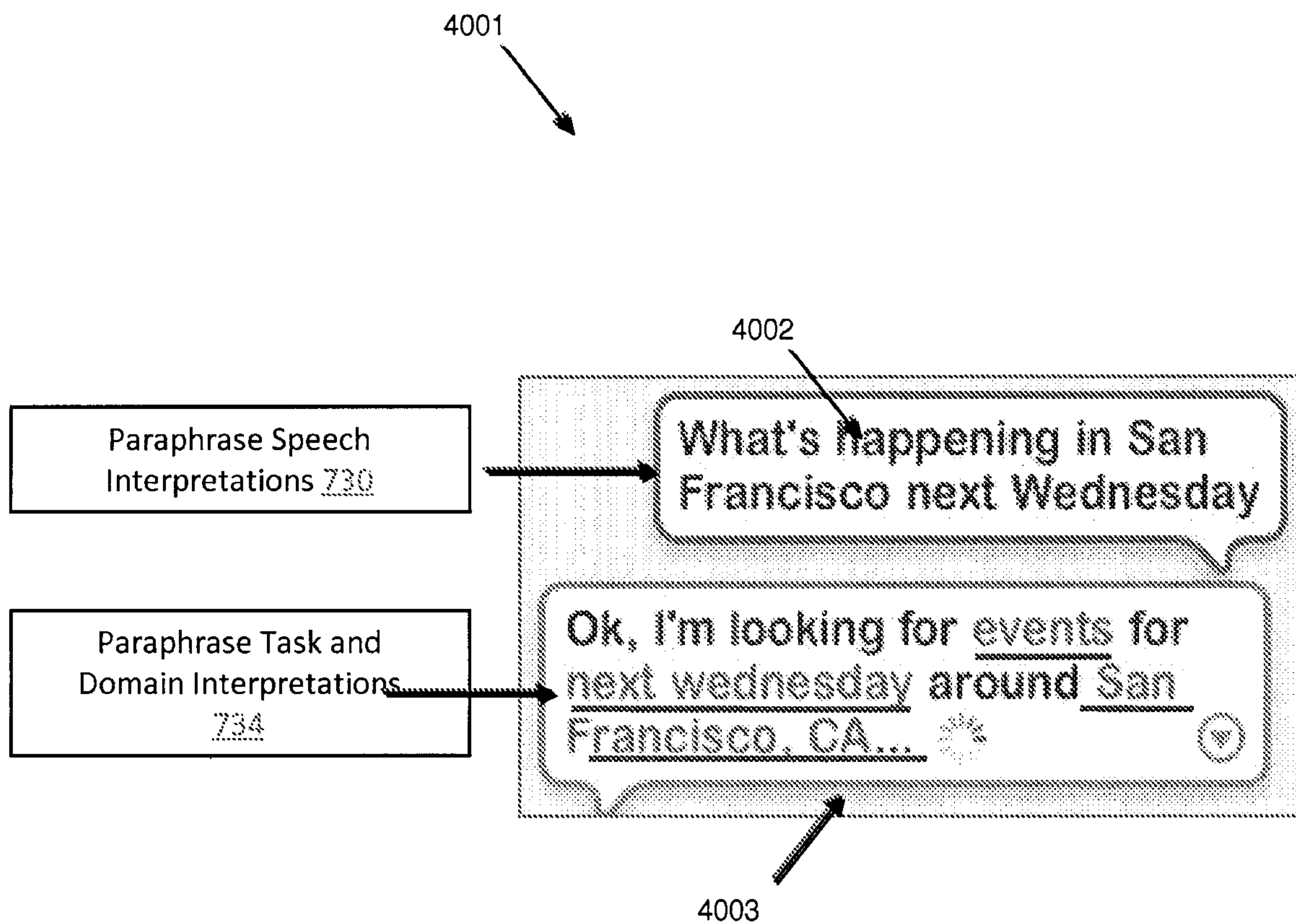

FIG. 40

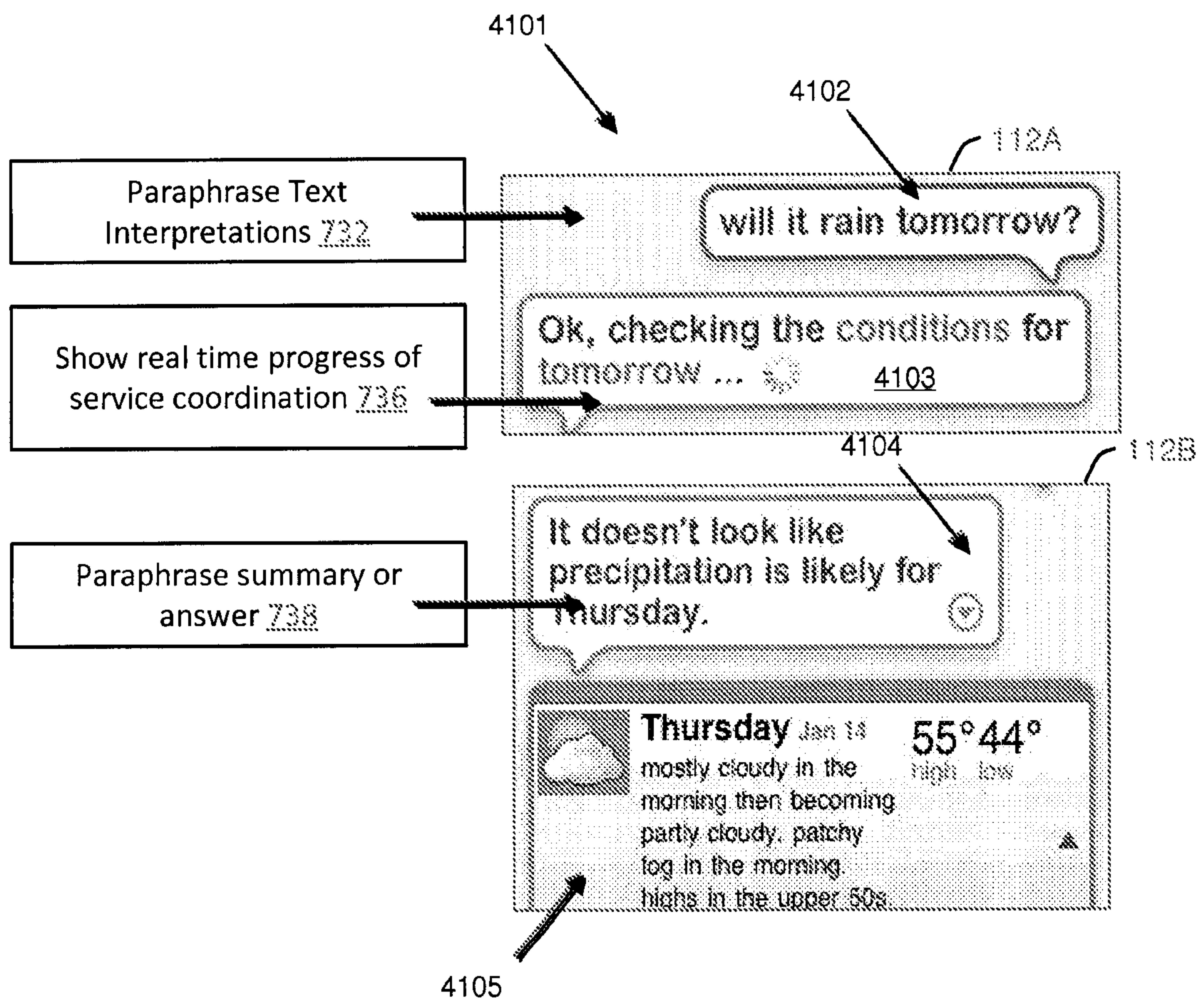

FIG. 41

42 / 47

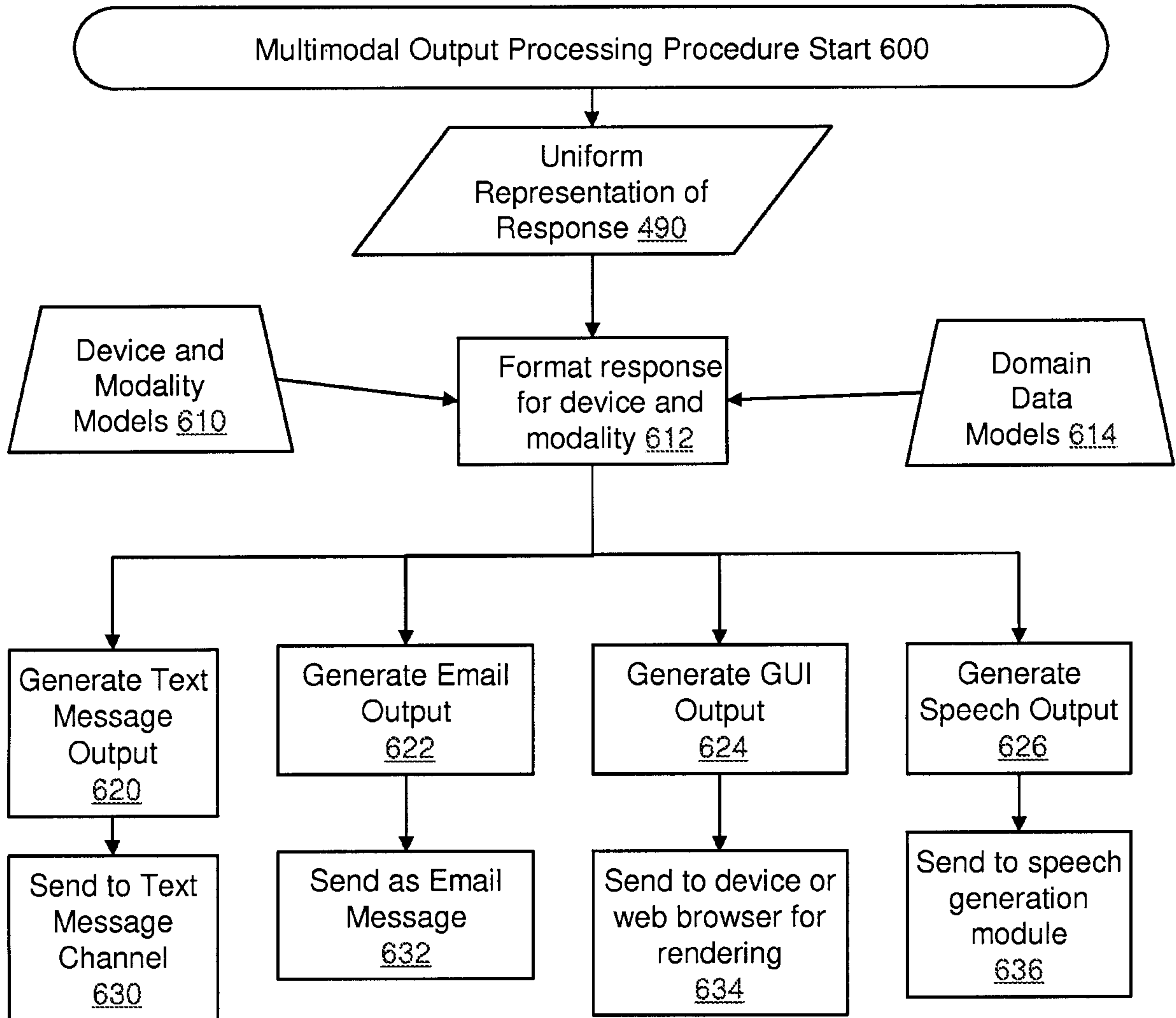





FIG. 42

4301

is it going to rain the day after tomorrow

It doesn't look like rain is likely for Tuesday.

 **Tuesday** high low **67° 55°**   
 mostly cloudy in the morning then becoming partly cloudy. highs in the upper 60s to mid 70s. west winds 5 to 10 mph.  
 Sunrise: 6:47 AM  
 Sunset: 6:31 PM

 **Tuesday night:**  
 partly cloudy. lows in the upper 50s. west winds 15 to 20 mph...becoming southwest 5 to 15 mph after midnight.

4302

50s. west winds 15 to 20 mph...becoming southwest 5 to 15 mph after midnight.

Powered by 

in new york

Here are the weather forecasts in in New York, NY for this coming Tuesday

 **Tuesday** high low **69° 61°**   
 mostly cloudy with isolated showers in the morning...then mostly sunny in the afternoon. highs around 70. east winds 10 to 15 mph. chance of rain 20 percent.

FIG. 43A

FIG. 43B

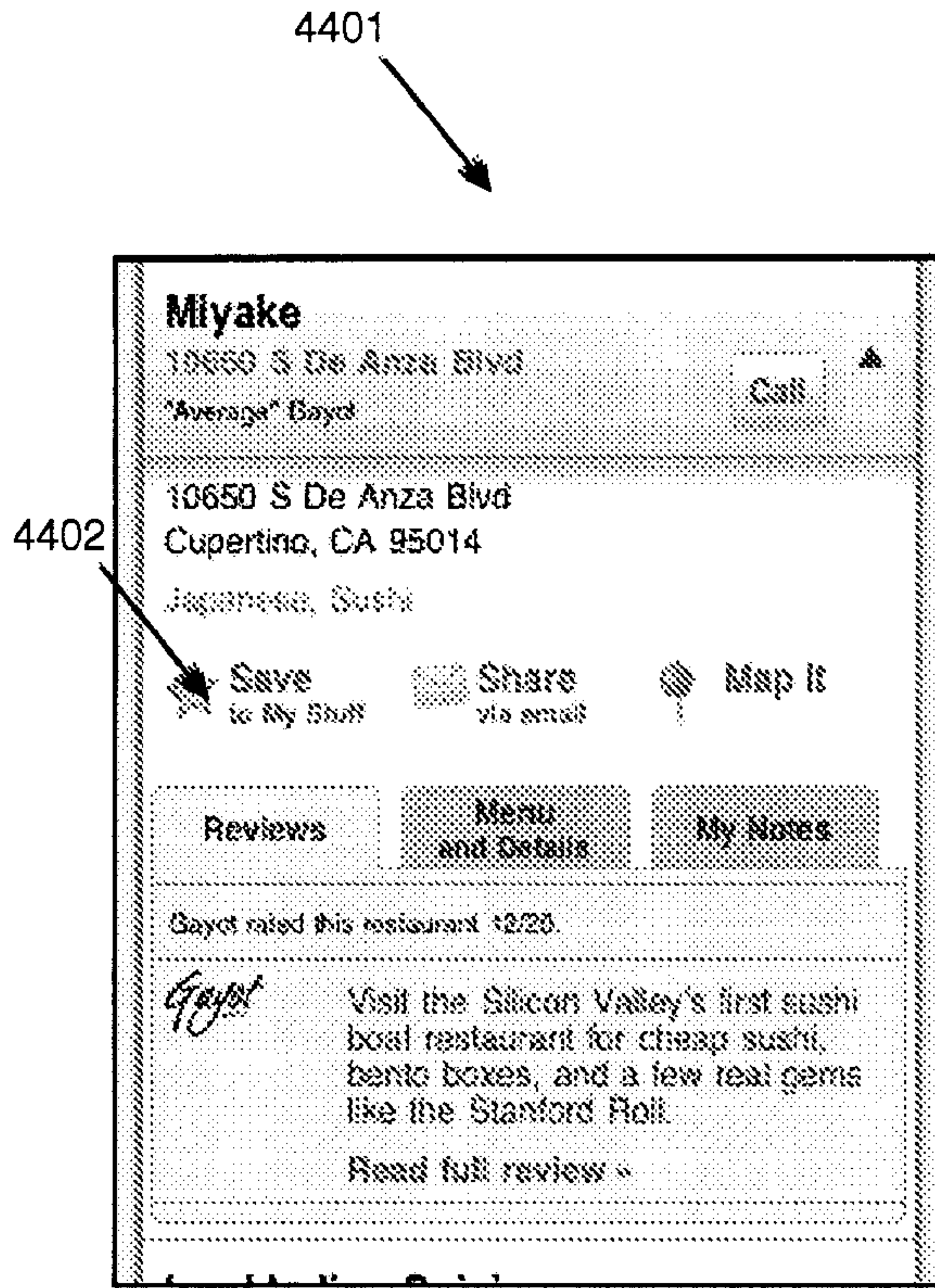

FIG. 44A

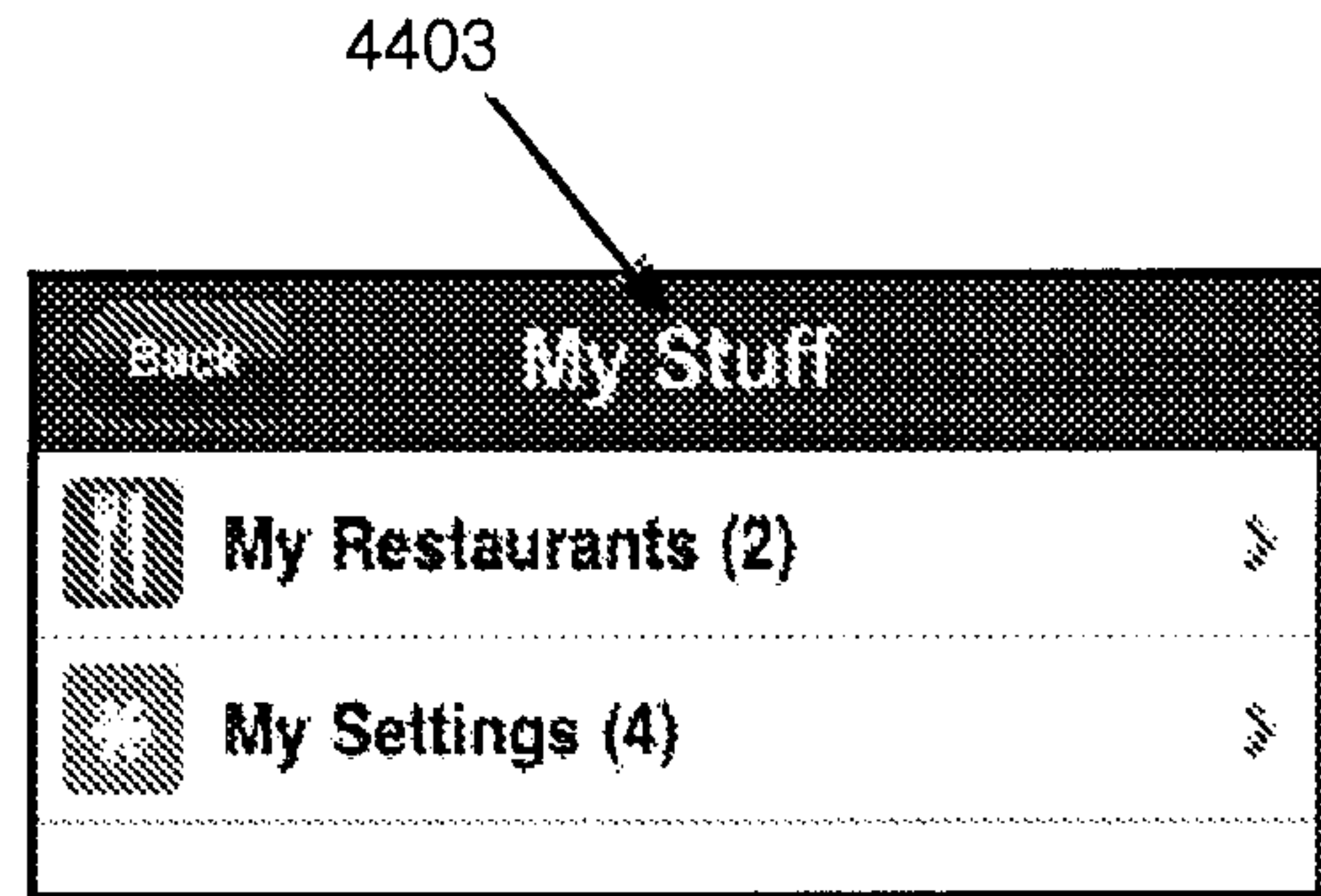

FIG. 44B

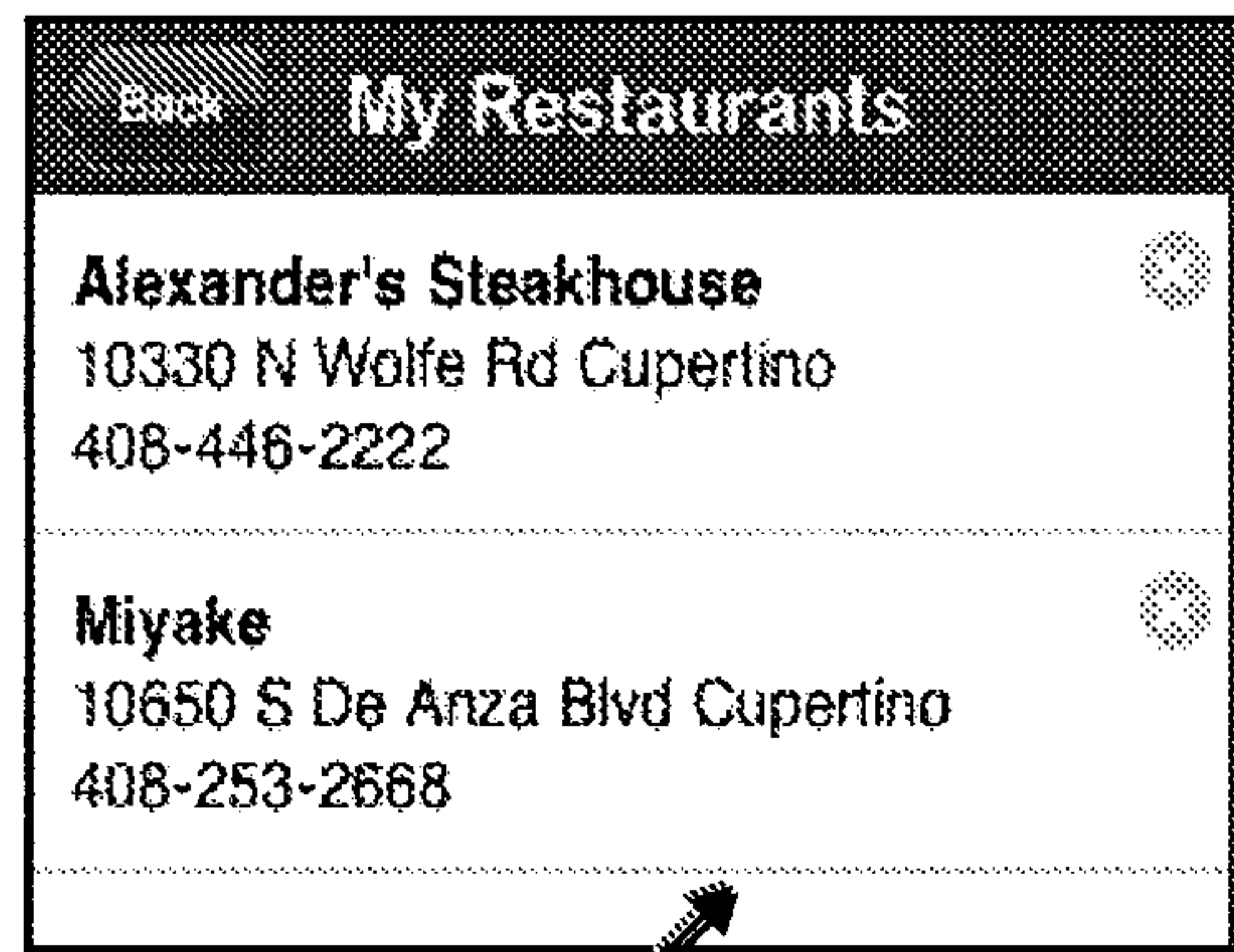

FIG. 44C

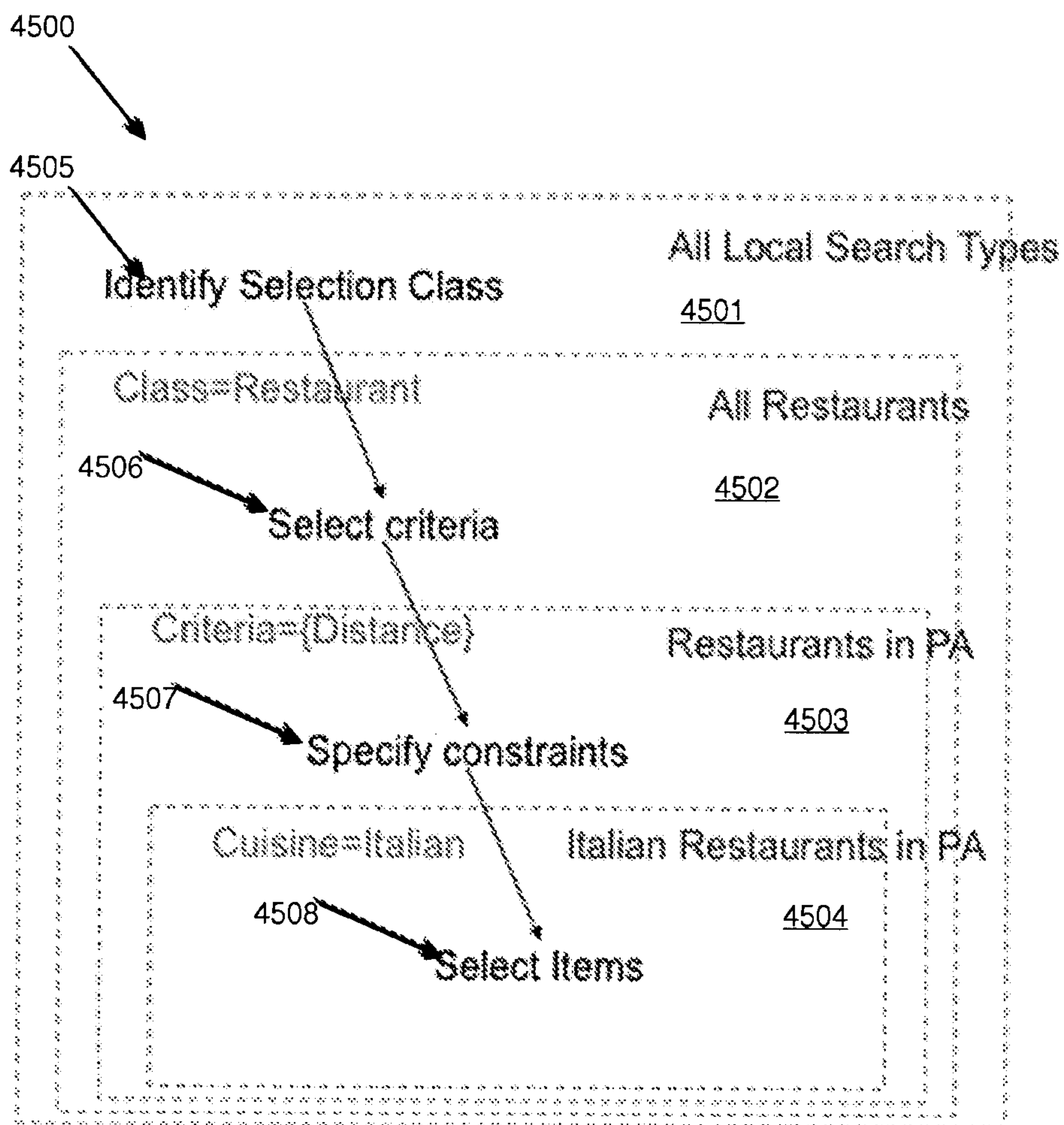

FIG. 45



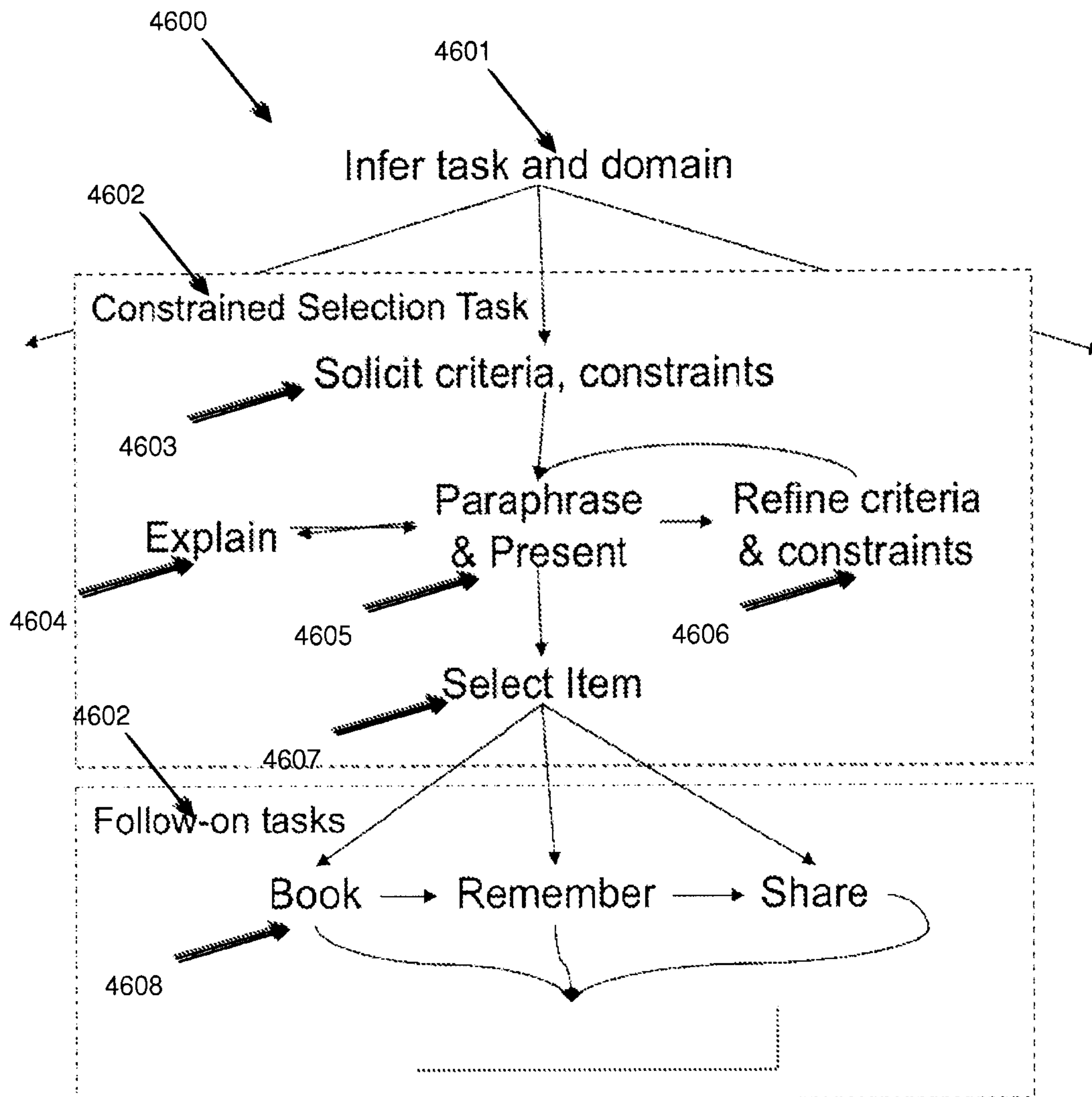
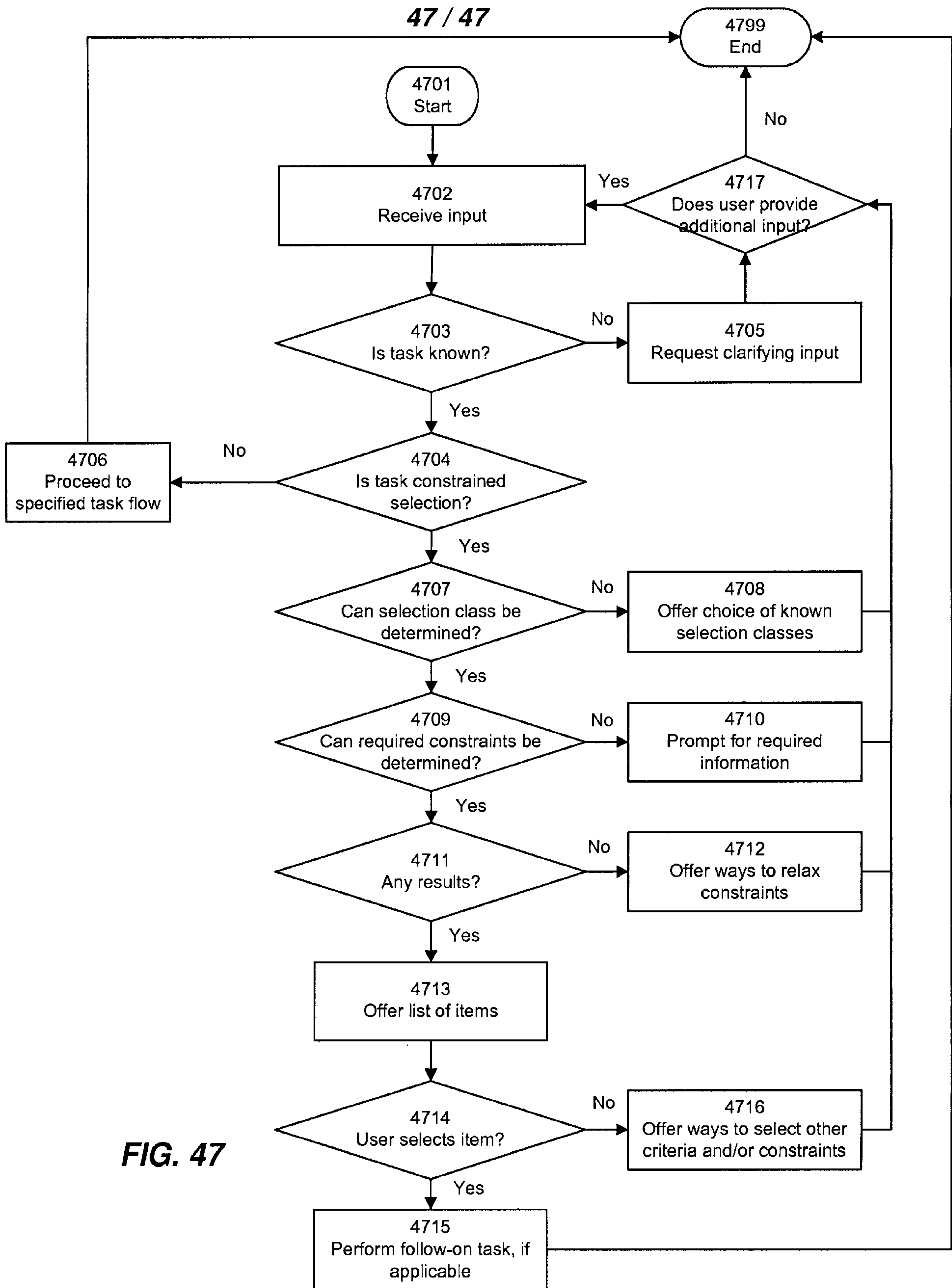

FIG. 46



**FIG. 47**

1002

# Intelligent Automated Assistant

